

**REFERENCE and
PRICE MANUAL
#15015
for Catalog #0802-20
Effective
January 1, 2015**

edsa

**The Innovative
Source for Storage
Systems & Furniture
in the Workplace**

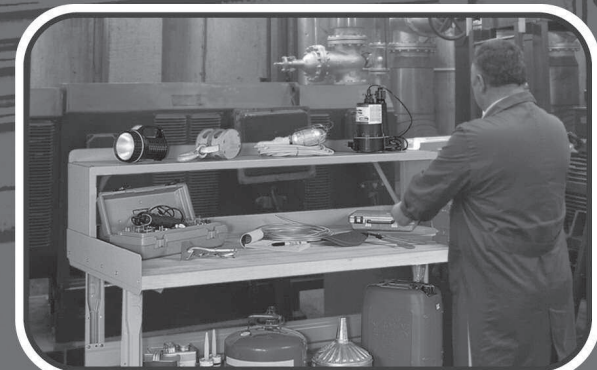

IMPORTANT INSTRUCTIONS

- **ORDER BY CATALOG PRODUCT NUMBER ONLY.** Be sure to include color suffix when appropriate. Order Faxline (773) 254-1303.
 - **WEIGHTS** as shown are approximate shipping weights only.
 - **PRICES** are F.O.B. our factory, Chicago, IL., and are subject to change without notice. We reserve the right to bill at prices in effect at time of shipment. The possession of this price list does not constitute an offer to sell.
 - **CONSULT** our nearest dealership, or factory, for prices and delivery of special sizes not shown in the catalog.
 - **DESIGN, SPECIFICATIONS, MATERIAL AND FINISH** are subject to change without notice.
 - **HARDWARE** is included for assembling all units and component parts.
 - **PACKING:** All like material is packed together, i.e., all shelves packed in one carton; all angles packed in one carton; all dividers packed in one carton, etc., unless it is to the customer's advantage to do otherwise.
- All packages are clearly marked showing size and model number of each item included.
- All material is packaged according to standard packaging regulations. Hardware and packing list will be found in specially marked carton.
- **INDUSTRIAL SHELVING AND SYSTEM II BULK STORAGE RACKS** are available in standard Edsal gray only. New style Z-beam welded frame bulk storage rack available in light gray only. Commercial shelving available in gray or tan only. Lockers are available in blue, gray or tan. All other products available in colors specified only. No special colors. Color must be specified on each order.
 - **UNLESS ROUTING** is specified on each order, our shipping department will route all shipments the best way (UPS prepaid and added to invoice, LTL truck collect, or contract carrier collect). Prepaid 3rd party freight billing available upon request. No freight charges (other than UPS) will be prepaid and added to Edsal invoicing.
 - **CHECK ALL SHIPMENTS** immediately for Damages in Transit and report any damage to your carrier. Your only recourse is with the delivering carrier and we will not accept return of merchandise damaged in transit.
 - **CHECK ALL SHIPMENTS** immediately for discrepancies and report this to your dealer or directly to the factory.
 - **NO MERCHANDISE IS TO BE RETURNED WITHOUT WRITTEN PERMISSION** from the factory and when so authorized, shipment must be returned transportation PREPAID showing pre-authorized return number on all packaging. Merchandise returned without written permission will be refused and held by the carrier at the shipper's expense, pending disposition.
 - **ALL RETURNED SHIPMENTS ARE SUBJECT TO A RESTOCKING CHARGE** of 25% plus all transportation charges unless Edsal is at fault. No credit will be issued for damaged merchandise.



MANUFACTURING COMPANY
www.edsal.com

4400 S. PACKERS AVENUE
CHICAGO, ILLINOIS 60609
PHONE (773) 254-0600
FAX (773) 254-1303

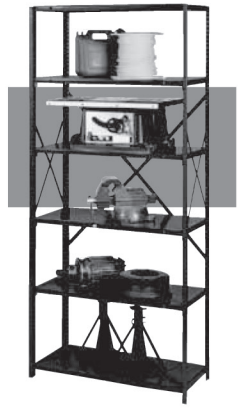

industrial shelving 4-14



specialty shelving and storage 15-21

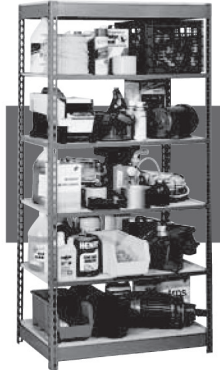

rivet lock 21-28



bulk rack 29-39



pallet rack 40



material handling 41-47

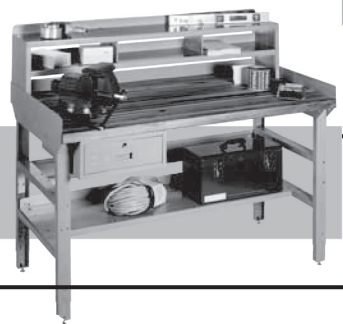

furniture in the workplace 47-65



cabinets 66-76



lockers 76-79



office products 79-84

index 85-86

Our catalog is designed to help you quickly find the product designed to meet your needs. Look for these helpful icons:



NEW Product. Edsal sets the industry standard in product innovation and development, with over 50 new products in this catalog!



No Nuts & Bolts Needed



Easy-to-Assemble



Set-Up



Adjustable-in-Height

**CLASS
A**

HEVILOAD^{PLUS} II

**22 GAUGE MEDIUM DUTY
OPEN & CLOSED TYPE
STEEL SHELVING**



CATALOG PAGES 8 & 9

OPEN SHELVING

CLOSED SHELVING

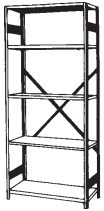
 5 SHELF UNIT CATALOG PAGE 8	Depth	Product Number	List Price Each Item	Approx. Shp. Wt.
	SHELVING SIZE 36" WIDE BY 85" HIGH			
	12	900-1235	158.61	63.0
	18	900-1835	190.14	73.0
	24	900-2435	224.62	83.0
	SHELVING SIZE 48" WIDE BY 85" HIGH			
	12	900-1245	189.47	73.0
	18	900-1845	222.23	85.5
	24	900-2445	271.36	98.0

 5 SHELF UNIT CATALOG PAGE 9	Depth	Product Number	List Price Each Item	Approx. Shp. Wt.
	SHELVING SIZE 36" WIDE BY 85" HIGH			
	12	901-1235	260.74	107.0
	18	901-1835	306.69	126.0
	24	901-2435	354.32	149.0
	SHELVING SIZE 48" WIDE BY 85" HIGH			
	12	901-1245	311.32	126.0
	18	901-1845	358.55	147.5
	24	901-2445	420.67	170.0

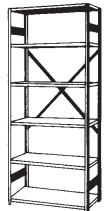
 6 SHELF UNIT CATALOG PAGE 8	Depth	Product Number	List Price Each Item	Approx. Shp. Wt.
	SHELVING SIZE 36" WIDE BY 85" HIGH			
	12	900-1236	175.22	69.0
	18	900-1836	212.47	81.0
	24	900-2436	253.02	93.0
	SHELVING SIZE 48" WIDE BY 85" HIGH			
	12	900-1246	212.25	81.0
	18	900-1846	250.96	96.0
	24	900-2446	309.10	111.0

 6 SHELF UNIT CATALOG PAGE 9	Depth	Product Number	List Price Each Item	Approx. Shp. Wt.
	SHELVING SIZE 36" WIDE BY 85" HIGH			
	12	901-1236	277.37	113.0
	18	901-1836	329.00	134.0
	24	901-2436	382.71	159.0
	SHELVING SIZE 48" WIDE BY 85" HIGH			
	12	901-1246	334.11	134.0
	18	901-1846	387.28	158.0
	24	901-2446	458.42	183.0

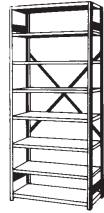
 8 SHELF UNIT CATALOG PAGE 8	Depth	Product Number	List Price Each Item	Approx. Shp. Wt.
	SHELVING SIZE 36" WIDE BY 85" HIGH			
	12	900-1238	208.47	81.0
	18	900-1838	257.10	97.0
	24	900-2438	309.84	113.0
	SHELVING SIZE 48" WIDE BY 85" HIGH			
	12	900-1248	257.84	97.0
	18	900-1848	308.43	117.0
	24	900-2448	384.59	137.0

 8 SHELF UNIT CATALOG PAGE 9	Depth	Product Number	List Price Each Item	Approx. Shp. Wt.
	SHELVING SIZE 36" WIDE BY 85" HIGH			
	12	901-1238	310.59	125.0
	18	901-1838	373.64	150.0
	24	901-2438	439.52	179.0
	SHELVING SIZE 48" WIDE BY 85" HIGH			
	12	901-1248	379.68	150.0
	18	901-1848	444.75	179.0
	24	901-2448	533.93	209.0

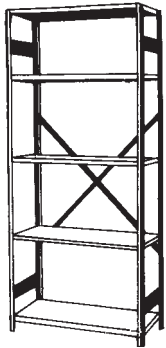

5

SHELF UNIT

CATALOG PAGE 10

	SHELVING SIZE 36" Wide x 85" High			SHELVING SIZE 42" Wide x 85" High			SHELVING SIZE 48" Wide x 85" High		
Depth	Product Number	List Price Each Item	Approx. Shp. Wt.	Product Number	List Price Each Item	Approx. Shp. Wt.	Product Number	List Price Each Item	Approx. Shp. Wt.
12	215-12-3	166.71	70	215-12-35	190.31	78	215-12-4	200.72	81
15	215-15-3	186.95	79	215-15-35	209.10	86	215-15-4	221.92	87
18	215-18-3	201.30	85	215-18-35	223.34	94	215-18-4	236.45	103
24	215-24-3	238.83	101	215-24-35	270.10	115	215-24-4	290.10	124
30	215-30-3	286.46	117	215-30-35	319.99	137	215-30-4	351.74	142
36	215-36-3	322.85	133	215-36-35	358.55	148	215-36-4	393.80	163

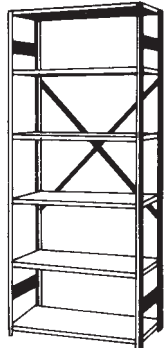

6

SHELF UNIT

CATALOG PAGE 10

	SHELVING SIZE 36" Wide x 85" High			SHELVING SIZE 42" Wide x 85" High			SHELVING SIZE 48" Wide x 85" High		
Depth	Product Number	List Price Each Item	Approx. Shp. Wt.	Product Number	List Price Each Item	Approx. Shp. Wt.	Product Number	List Price Each Item	Approx. Shp. Wt.
12	216-12-3	184.95	77	216-12-35	213.28	86	216-12-4	225.74	90
15	216-15-3	208.88	88	216-15-35	235.46	96	216-15-4	250.84	98
18	216-18-3	225.86	104	216-18-35	251.79	105	216-18-4	268.03	116
24	216-24-3	270.09	115	216-24-35	307.57	130	216-24-4	331.59	142
30	216-30-3	326.70	133	216-30-35	366.82	154	216-30-4	404.89	169
36	216-36-3	370.06	151	216-36-35	412.81	169	216-36-4	455.04	187

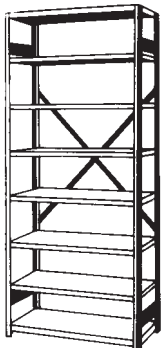

8

SHELF UNIT

CATALOG PAGE 10

	SHELVING SIZE 36" Wide x 85" High			SHELVING SIZE 42" Wide x 85" High			SHELVING SIZE 48" Wide x 85" High		
Depth	Product Number	List Price Each Item	Approx. Shp. Wt.	Product Number	List Price Each Item	Approx. Shp. Wt.	Product Number	List Price Each Item	Approx. Shp. Wt.
12	218-12-3	221.42	91	218-12-35	259.21	102	218-12-4	275.83	108
15	218-15-3	252.76	104	218-15-35	288.14	116	218-15-4	308.69	120
18	218-18-3	274.96	124	218-18-35	310.13	128	218-18-4	331.16	142
24	218-24-3	332.55	154	218-24-35	382.55	160	218-24-4	414.58	177
30	218-30-3	407.19	165	218-30-35	460.53	181	218-30-4	511.21	214
36	218-36-3	464.45	188	218-36-35	521.28	201	218-36-4	577.54	216

**CLASS
A**

HEVILOAD^{PLUS} II

**20 GAUGE HEAVY DUTY
CLOSED TYPE
STEEL SHELVING**



CATALOG PAGE 11



5

SHELF UNIT

CATALOG PAGE 11

	SHELVING SIZE 36" Wide x 85" High			SHELVING SIZE 42" Wide x 85" High			SHELVING SIZE 48" Wide x 85" High		
Depth	Product Number	List Price Each Item	Approx. Shp. Wt.	Product Number	List Price Each Item	Approx. Shp. Wt.	Product Number	List Price Each Item	Approx. Shp. Wt.
12	225-12-3	268.84	109	225-12-35	298.46	117	225-12-4	322.57	121
15	225-15-3	308.69	121	225-15-35	323.53	126	225-15-4	363.34	128
18	225-18-3	317.84	132	225-18-35	345.86	141	225-18-4	372.75	140
24	225-24-3	368.52	157	225-24-35	405.80	171	225-24-4	439.42	180
30	225-30-3	431.51	181	225-30-35	477.80	201	225-30-4	515.82	206

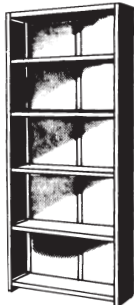

6

SHELF UNIT

CATALOG PAGE 11

	SHELVING SIZE 36" Wide x 85" High			SHELVING SIZE 42" Wide x 85" High			SHELVING SIZE 48" Wide x 85" High		
Depth	Product Number	List Price Each Item	Approx. Shp. Wt.	Product Number	List Price Each Item	Approx. Shp. Wt.	Product Number	List Price Each Item	Approx. Shp. Wt.
12	226-12-3	287.09	116	226-12-35	321.44	126	226-12-4	347.61	131
15	226-15-3	330.63	130	226-15-35	349.90	136	226-15-4	392.27	139
18	226-18-3	342.39	142	226-18-35	374.80	153	226-18-4	404.33	153
24	226-24-3	399.77	170	226-24-35	443.28	186	226-24-4	480.91	197
30	226-30-3	471.76	197	226-30-35	524.65	219	226-30-4	568.98	227



8

SHELF UNIT

CATALOG PAGE 11

	SHELVING SIZE 36" Wide x 85" High			SHELVING SIZE 42" Wide x 85" High			SHELVING SIZE 48" Wide x 85" High		
Depth	Product Number	List Price Each Item	Approx. Shp. Wt.	Product Number	List Price Each Item	Approx. Shp. Wt.	Product Number	List Price Each Item	Approx. Shp. Wt.
12	228-12-3	323.56	130	228-12-35	367.36	142	228-12-4	397.69	151
15	228-15-3	374.51	148	228-15-35	402.58	156	228-15-4	450.11	161
18	228-18-3	391.51	162	228-18-35	432.65	177	228-18-4	467.49	179
24	228-24-3	462.25	196	228-24-35	518.26	216	228-24-4	563.91	231
30	228-30-3	552.25	229	228-30-35	618.35	255	228-30-4	675.31	269

**CLASS
A**

HEVILOAD PLUS

**18 GAUGE EXTRA HEAVY DUTY
OPEN & CLOSED TYPE
STEEL SHELVING**





CATALOG PAGES 12 & 13

OPEN SHELVING

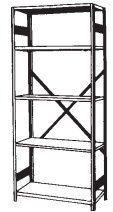
CLOSED SHELVING

 5 SHELF UNIT CATALOG PAGE 12	Depth	Product Number	List Price Each Item	Approx. Shp. Wt.
	SHELVING SIZE 36" WIDE BY 85" HIGH			
	12	800-1235	199.39	80.5
	18	800-1835	240.81	97.5
	24	800-2435	285.47	113.0
	SHELVING SIZE 48" WIDE BY 85" HIGH			
	12	800-1245	240.74	95.5
	18	800-1845	283.00	115.5
	24	800-2445	347.81	137.0

 5 SHELF UNIT CATALOG PAGE 13	Depth	Product Number	List Price Each Item	Approx. Shp. Wt.
	SHELVING SIZE 36" WIDE BY 85" HIGH			
	12	801-1235	301.56	124.5
	18	801-1835	357.35	150.0
	24	801-2435	415.17	179.0
	SHELVING SIZE 48" WIDE BY 85" HIGH			
	12	801-1245	362.60	148.5
	18	801-1845	419.31	177.5
	24	801-2445	497.12	209.0

 6 SHELF UNIT CATALOG PAGE 12	Depth	Product Number	List Price Each Item	Approx. Shp. Wt.
	SHELVING SIZE 36" WIDE BY 85" HIGH			
	12	800-1236	224.18	90.0
	18	800-1836	273.25	109.8
	24	800-2436	326.05	129.0
	SHELVING SIZE 48" WIDE BY 85" HIGH			
	12	800-1246	273.77	108.0
	18	800-1846	323.87	132.0
	24	800-2446	400.84	157.8

 6 SHELF UNIT CATALOG PAGE 13	Depth	Product Number	List Price Each Item	Approx. Shp. Wt.
	SHELVING SIZE 36" WIDE BY 85" HIGH			
	12	801-1236	326.33	134.0
	18	801-1836	389.80	162.8
	24	801-2436	455.74	195.0
	SHELVING SIZE 48" WIDE BY 85" HIGH			
	12	801-1246	395.64	161.0
	18	801-1846	460.20	194.0
	24	801-2446	550.18	229.8

 8 SHELF UNIT CATALOG PAGE 12	Depth	Product Number	List Price Each Item	Approx. Shp. Wt.
	SHELVING SIZE 36" WIDE BY 85" HIGH			
	12	800-1238	273.73	109.0
	18	800-1838	338.14	135.4
	24	800-2438	407.19	161.0
	SHELVING SIZE 48" WIDE BY 85" HIGH			
	12	800-1248	339.84	133.0
	18	800-1848	405.65	165.0
	24	800-2448	506.94	199.4

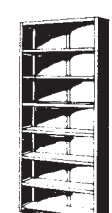
 8 SHELF UNIT CATALOG PAGE 13	Depth	Product Number	List Price Each Item	Approx. Shp. Wt.
	SHELVING SIZE 36" WIDE BY 85" HIGH			
	12	801-1238	375.88	153.0
	18	801-1838	454.70	188.4
	24	801-2438	536.88	227.0
	SHELVING SIZE 48" WIDE BY 85" HIGH			
	12	801-1248	461.72	186.0
	18	801-1848	541.98	227.0
	24	801-2448	656.25	271.4

**CLASS
A**

HEVILOAD^{PLUS} STANDARD BIN UNITS
All Units 36" Wide x 85" High



CATALOG PAGES 14 - 16

14 Bins  CATALOG PAGE 15	Depth	Product Number	List Price Each Item	Approx. Shp. Wt.
	12	2301-12	357.12	138
	18	2301-18	442.12	170
24	2301-24	525.35	209	

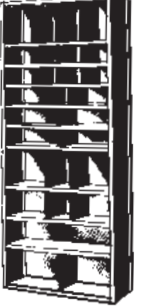
28 Bins  CATALOG PAGE 15	Depth	Product Number	List Price Each Item	Approx. Shp. Wt.
	12	2305-12	452.17	162
	18	2305-18	567.96	203
24	2305-24	687.69	249	

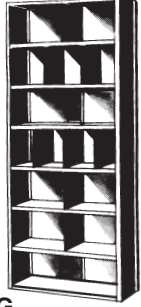
15 Bins  CATALOG PAGE 15	Depth	Product Number	List Price Each Item	Approx. Shp. Wt.
	12	2302-12	362.74	139
	18	2302-18	450.20	173
24	2302-24	535.16	212	

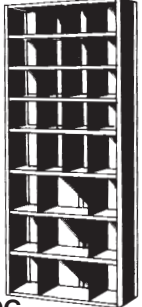
29 Bins  CATALOG PAGE 15	Depth	Product Number	List Price Each Item	Approx. Shp. Wt.
	12	2306-12	448.93	158
	18	2306-18	560.63	200
24	2306-24	678.58	250	

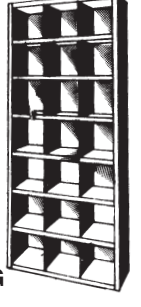
21 Bins  CATALOG PAGE 15	Depth	Product Number	List Price Each Item	Approx. Shp. Wt.
	12	2303-12	396.41	144
	18	2303-18	498.51	183
24	2303-24	594.19	223	

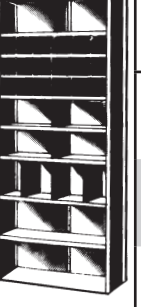
29 Bins  CATALOG PAGE 16	Depth	Product Number	List Price Each Item	Approx. Shp. Wt.
	12	2307-12	434.89	163
	18	2307-18	542.87	211
24	2307-24	657.61	261	

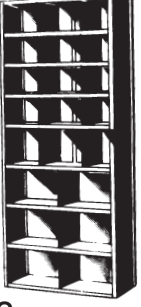
21 Bins  CATALOG PAGE 15	Depth	Product Number	List Price Each Item	Approx. Shp. Wt.
	12	2304-12	405.68	150
	18	2304-18	502.46	190
24	2304-24	605.14	234	

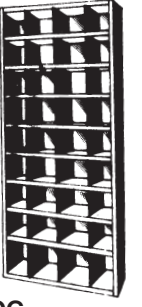
36 Bins  CATALOG PAGE 16	Depth	Product Number	List Price Each Item	Approx. Shp. Wt.
	12	2308-12	495.84	170
	18	2308-18	614.68	221
24	2308-24	753.15	275	

**CLASS
A**

HEVI DAD PLUS

STANDARD BIN UNITS

All Units 36" Wide x 85" High

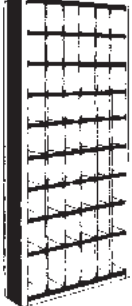

CATALOG PAGES 16 & 17

 54 Bins CATALOG PAGE 16	Depth	Product Number	List Price Each Item	Approx. Shp. Wt.
	12	2309-12	590.21	178
	18	2309-18	734.57	232
	24	2309-24	909.22	291

 27 Bins CATALOG PAGE 17	Depth	Product Number	List Price Each Item	Approx. Shp. Wt.
	12	2314-12	474.42	168
	18	2314-18	581.31	209
	24	2314-24	690.88	254

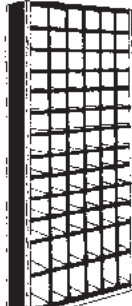
 78 Bins CATALOG PAGE 16	Depth	Product Number	List Price Each Item	Approx. Shp. Wt.
	12	2310-12	674.84	204
	18	2310-18	857.79	268
	24	2310-24	1,066.80	277

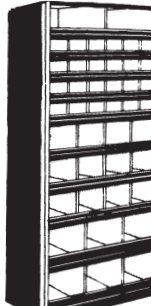
 44 Bins CATALOG PAGE 17	Depth	Product Number	List Price Each Item	Approx. Shp. Wt.
	12	2315-12	583.89	213
	18	2315-18	716.80	223
	24	2315-24	863.40	269

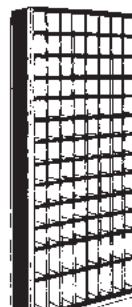
 104 Bins CATALOG PAGE 17	Depth	Product Number	List Price Each Item	Approx. Shp. Wt.
	12	2311-12	773.87	200
	18	2311-18	987.71	262
	24	2311-24	1,235.95	329

 34 Bins 18 Drawers CATALOG PAGE 17	Depth	Product Number	List Price Each Item	Approx. Shp. Wt.
	12	2316-12	861.75	212
	18	2316-18	1,053.83	275

 16 Bins CATALOG PAGE 17	Depth	Product Number	List Price Each Item	Approx. Shp. Wt.
	12	2313-12	400.24	148
	18	2313-18	488.99	182
	24	2313-24	572.73	228

 84 Drawers CATALOG PAGE 17	Depth	Product Number	List Price Each Item	Approx. Shp. Wt.
	12	2317-12	1,729.99	405
	18	2317-18	2,063.27	536

**CLASS
A**

STEEL DRAWER UNITS & SHELF DRAWERS



CATALOG PAGES 18 & 19

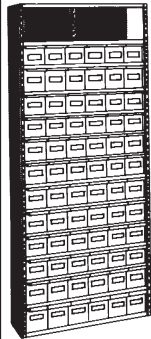

Product Number	Number of Drawers	Drawer Size W" x D"	List Price Each Item	Approx. Shp. Wt.
2318-12	72	5 ⁹ / ₁₆ x 11 ³ / ₄	1,526.76	314
2318-18	72	5 ⁹ / ₁₆ x 17 ³ / ₄	1,822.27	430

36"W x 12"D or 18"D x 85"H

CATALOG PAGE 18

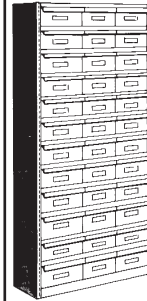

Product Number	Number of Drawers	Drawer Size W" x D"	List Price Each Item	Approx. Shp. Wt.
2321-12	36	11 ¹ / ₄ x 11 ³ / ₄	1,352.73	296
2321-18	36	11 ¹ / ₄ x 17 ³ / ₄	1,587.33	372

36"W x 12"D or 18"D x 73"H

CATALOG PAGE 19

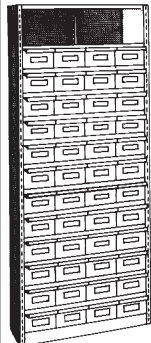

Product Number	Number of Drawers	Drawer Size W" x D"	List Price Each Item	Approx. Shp. Wt.
2319-12	48	8 ³ / ₈ x 11 ³ / ₄	1,488.67	314
2319-18	48	8 ³ / ₈ x 17 ³ / ₄	1,797.16	406

36"W x 12"D or 18"D x 85"H

CATALOG PAGE 18

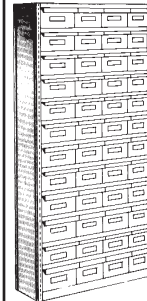

Product Number	Number of Drawers	Drawer Size W" x D"	List Price Each Item	Approx. Shp. Wt.
2322-12	48	8 ³ / ₈ x 11 ³ / ₄	1,444.58	296
2322-18	48	8 ³ / ₈ x 17 ³ / ₄	1,748.01	384

36"W x 12"D or 18"D x 73"H

CATALOG PAGE 19

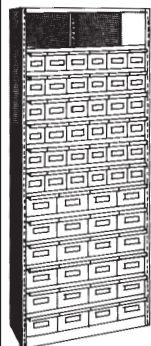

Product Number	Number of Drawers	Drawer Size W" x D"	List Price Each Item	Approx. Shp. Wt.
2320-12	36	5 ⁹ / ₁₆ x 11 ³ / ₄	1,507.71	314
	24	8 ³ / ₈ x 11 ³ / ₄		
2320-18	36	5 ⁹ / ₁₆ x 17 ³ / ₄	1,809.72	418
	24	8 ³ / ₈ x 17 ³ / ₄		

36"W x 12"D or 18"D x 85"H

CATALOG PAGE 18

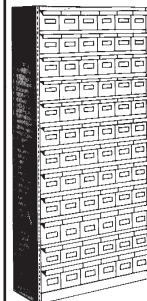

Product Number	Number of Drawers	Drawer Size W" x D"	List Price Each Item	Approx. Shp. Wt.
2323-12	72	5 ⁹ / ₁₆ x 11 ³ / ₄	1,482.68	296
2323-18	72	5 ⁹ / ₁₆ x 17 ³ / ₄	1,609.72	408

36"W x 12"D or 18"D x 73"H

CATALOG PAGE 19

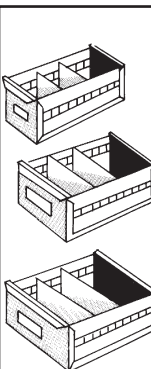

SHELF DRAWERS* CATALOG PAGE 18

Product Number	Product Size W" x D" x H"	List Price Each Item	Approx. Shp. Wt.
270-121	5 ⁹ / ₁₆ x 11 ³ / ₄ x 4 ⁵ / ₈	15.29	2
270-181	5 ⁹ / ₁₆ x 17 ³ / ₄ x 4 ⁵ / ₈	17.93	3
280-121	8 ³ / ₈ x 11 ³ / ₄ x 4 ⁵ / ₈	22.15	3
280-181	8 ³ / ₈ x 17 ³ / ₄ x 4 ⁵ / ₈	26.36	4
290-121	11 ¹ / ₄ x 11 ³ / ₄ x 4 ⁵ / ₈	26.98	4
290-181	11 ¹ / ₄ x 17 ³ / ₄ x 4 ⁵ / ₈	30.69	5
DIVIDERS**			
	W" x H"		
270-01	5 ⁹ / ₁₆ x 4 ⁵ / ₈	1.45	.5
280-01	8 ³ / ₈ x 4 ⁵ / ₈	2.66	.5
290-01	11 ¹ / ₄ x 4 ⁵ / ₈	3.50	.5

* Drawers packed 12 per carton.**Dividers packed 50 per carton. Must order in complete carton quantities.

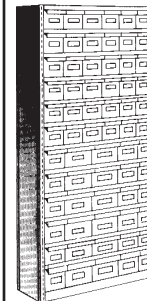

Product Number	Number of Drawers	Drawer Size W" x D"	List Price Each Item	Approx. Shp. Wt.
2324-12	36	5 ⁹ / ₁₆ x 11 ³ / ₄	1,463.63	296
	24	8 ³ / ₈ x 11 ³ / ₄		
2324-18	36	5 ⁹ / ₁₆ x 17 ³ / ₄	1,760.56	396
	24	8 ³ / ₈ x 17 ³ / ₄		

36"W x 12"D or 18"D x 73"H

CATALOG PAGE 19

**CLASS
C**

DRAWER & DOOR CASES



CATALOG PAGE 20



Product Number	Description	List Price Ea.	Shpg. Wt. (Lbs.)
DC3401	Door Case	-	56
DC3402	2 Drawer Case	-	79
DC3403	3 Drawer Case	-	109
	Divider Kit	-	4

DISCONTINUED

DCK3405



**CLASS
A**

DOOR UNITS



CATALOG PAGE 20



Product Number	Product Size W" x H"	List Price Each Item	Approx. Shpg. Wt.
260	36 x 85	346.05	75
261	36 x 37	195.86	35
262	36 x 48	224.04	43
263	36 x 73	306.18	72

**CLASS
A**

LEDGE SHELVING



CATALOG PAGE 21

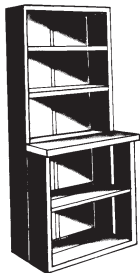

NOTE: Model 246 is the same as 245 except it has two Model 261 door sets.



Product Number	Product Size W" x D" x H"	List Price Each Item	Approx. Shp. Wt.
245-1224	36 x 24 x 85	470.59	167
245-1527	36 x 27 x 85	514.16	180
245-1830	36 x 30 x 85	525.93	195
245-2436	36 x 36 x 85	583.28	225
242	36 x 12 x 39	189.27	45
246-1224	36 x 24 x 85	862.33	202
246-1527	36 x 27 x 85	905.87	215
246-1830	36 x 30 x 85	917.64	230
246-2436	36 x 36 x 85	975.00	260

**CLASS
C**

SERVICE COUNTERS



CATALOG PAGE 21

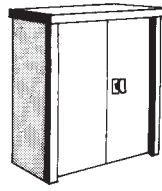
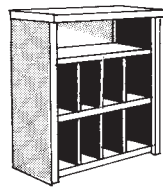
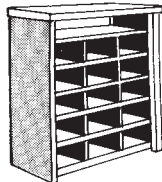
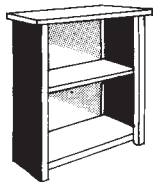

Product Number	Product Size W" x D" x H"	List Price Each Item	Approx. Shp. Wt.
250-24-S	37 x 24 x 39	326.32	73
250-24-I	36 x 24 x 39	321.89	70
254-24*	36 x 24	23.51	14
251-24-S	37 x 24 x 39	481.70	123
251-24-I	36 x 24 x 39	477.28	120
252-24-S	37 x 24 x 39	408.82	95
252-24-I	36 x 24 x 39	404.39	92
253-24-S	37 x 24 x 39	522.16	108
253-24-I	36 x 24 x 39	517.75	105

*Extra shelves



6 SHELF OPEN UNITS

Starter & Add-On Style

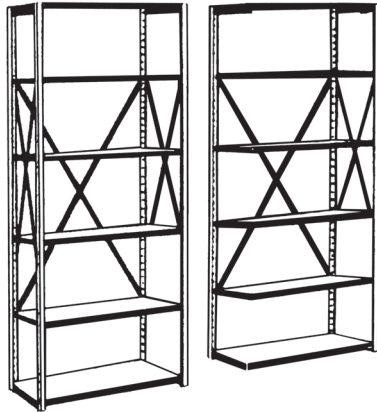

24 GAUGE

Size	Starter	List Ea.	Weight	Add-On	List Ea.	Weight
36 x 12 x 85	UC5512	218.05	76.0	UC5518	181.54	62.5
36 x 18 x 85	UC5513	248.80	85.0	UC5519	212.28	71.5
36 x 24 x 85	UC5514	280.80	97.0	UC5520	244.31	83.5
48 x 12 x 85	UC5515	255.50	85.0	UC5521	218.97	71.5
48 x 18 x 85	UC5516	313.35	97.0	UC5522	276.83	83.5
48 x 24 x 85	UC5517	354.78	115.0	UC5523	318.28	101.5

22 GAUGE

Size	Starter	List Ea.	Weight	Add-On	List Ea.	Weight
36 x 12 x 85	UC5312	223.68	85.0	UC5318	187.18	71.5
36 x 18 x 85	UC5313	259.07	94.0	UC5319	222.53	80.5
36 x 24 x 85	UC5314	289.70	115.0	UC5320	253.20	101.5
48 x 12 x 85	UC5315	266.79	94.0	UC5321	230.28	80.5
48 x 18 x 85	UC5316	324.13	115.0	UC5322	287.60	101.5
48 x 24 x 85	UC5317	367.65	133.0	UC5323	331.13	119.5

20 GAUGE

Size	Starter	List Ea.	Weight	Add-On	List Ea.	Weight
36 x 12 x 85	UC5112	250.26	89.0	UC5118	213.75	76.5
36 x 18 x 85	UC5113	294.32	102.0	UC5119	257.81	89.0
36 x 24 x 85	UC5114	340.34	124.0	UC5120	303.82	110.5
48 x 12 x 85	UC5115	297.44	102.0	UC5121	260.93	89.5
48 x 18 x 85	UC5116	342.43	124.5	UC5122	305.92	110.0
48 x 24 x 85	UC5117	411.59	149.0	UC5123	375.07	135.5

6 SHELF CLOSED UNITS

Starter & Add-On Style



24 GAUGE

Size	Starter	List Ea.	Weight	Add-On	List Ea.	Weight
36 x 12 x 85	UC5548	314.43	118.5	UC5554	266.45	97.0
36 x 18 x 85	UC5549	359.59	136.5	UC5555	306.00	110.5
36 x 24 x 85	UC5550	404.74	161.5	UC5556	346.57	127.5
48 x 12 x 85	UC5551	370.09	136.0	UC5557	322.11	114.5
48 x 18 x 85	UC5552	442.43	157.0	UC5558	388.75	131.0
48 x 24 x 85	UC5553	496.84	185.0	UC5559	438.74	154.0

22 GAUGE

Size	Starter	List Ea.	Weight	Add-On	List Ea.	Weight
36 x 12 x 85	UC5348	320.07	127.5	UC5354	272.10	106.0
36 x 18 x 85	UC5349	369.86	145.5	UC5355	316.23	119.5
36 x 24 x 85	UC5350	413.64	179.5	UC5356	355.45	145.5
48 x 12 x 85	UC5351	381.39	145.0	UC5357	333.40	123.5
48 x 18 x 85	UC5352	453.19	175.0	UC5358	399.54	149.0
48 x 24 x 85	UC5353	509.72	203.0	UC5359	451.60	172.0

20 GAUGE

Size	Starter	List Ea.	Weight	Add-On	List Ea.	Weight
36 x 12 x 85	UC5148	346.65	126.5	UC5154	298.68	107.5
36 x 18 x 85	UC5149	405.10	147.5	UC5155	351.50	124.0
36 x 24 x 85	UC5150	464.29	178.5	UC5156	406.08	150.0
48 x 12 x 85	UC5151	412.05	147.0	UC5157	364.04	128.0
48 x 18 x 85	UC5152	471.48	177.0	UC5158	417.84	153.5
48 x 24 x 85	UC5153	553.66	211.0	UC5159	495.54	182.5

6 SHELF UNITS

Free-Standing Style

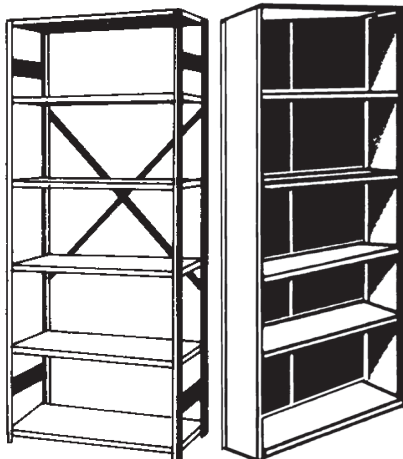

24 GAUGE

Size	Open	List Ea.	Weight	Closed	List Ea.	Weight
36 x 12 x 85	UA5572	184.31	66.0	UA5578	280.72	108.5
36 x 18 x 85	UA5573	218.13	75.0	UA5579	328.91	126.5
36 x 24 x 85	UA5574	254.17	87.0	UA5580	378.10	151.5
48 x 12 x 85	UA5575	221.78	75.0	UA5581	336.39	126.5
48 x 18 x 85	UA5576	282.66	87.0	UA5582	411.73	147.0
48 x 24 x 85	UA5577	328.13	105.0	UA5583	470.20	175.0

22 GAUGE

Size	Open	List Ea.	Weight	Closed	List Ea.	Weight
36 x 12 x 85	UA5372	189.98	75.0	UA5378	286.36	117.5
36 x 18 x 85	UA5373	228.35	84.0	UA5379	339.14	135.5
36 x 24 x 85	UA5374	263.08	105.0	UA5380	386.99	169.5
48 x 12 x 85	UA5375	233.06	84.0	UA5381	347.68	135.0
48 x 18 x 85	UA5376	293.45	105.0	UA5382	422.50	165.0
48 x 24 x 85	UA5377	341.01	123.0	UA5383	483.08	193.0

20 GAUGE

Size	Open	List Ea.	Weight	Closed	List Ea.	Weight
36 x 12 x 85	UA5172	216.54	81.0	UA5178	312.95	123.5
36 x 18 x 85	UA5173	263.61	93.0	UA5179	374.41	144.5
36 x 24 x 85	UA5174	313.70	114.0	UA5180	437.63	178.5
48 x 12 x 85	UA5175	263.73	93.0	UA5181	378.34	144.0
48 x 18 x 85	UA5176	311.75	114.0	UA5182	440.81	174.0
48 x 24 x 85	UA5177	384.94	138.0	UA5183	527.01	208.0

**CLASS
A**



STANDARD SHELVING ACCESSORIES

(Industrial Gray only)



CATALOG PAGES 26 & 27

ANGLE POST UPRIGHTS



Product Number	Size (H")	List Ea.	Shpg. Wt.
49-P	49	8.67	4.0
61-P	61	10.33	5.0
73-P	73	12.65	6.0
85-P	85	14.27	7.0
97-P	97	15.96	8.0
109-P	109	17.93	9.0
121-P	121	19.96	10.0

CATALOG PAGE 27

BACK SWAY BRACE



Product Number	Size W" x L"	List Ea.	Shpg. Wt.
36-BB	1 x 44	6.74	2.0
42-BB	1 x 50	7.24	2.5
48-BB	1 x 56	7.40	3.0

CATALOG PAGE 27

ULTRACAP BOX POST UPRIGHTS

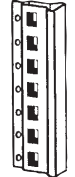

Product Number	Height	List Ea.	Shpg. Wt.
UCP7300	73"	26.53	10.0
UCP8500	85"	29.87	11.0
UCP9700	97"	33.55	13.0

CATALOG PAGE 27

STRINGER STYLE SIDE BRACES



Product Number	Size D" x H"	List Pair	Shpg. Wt.
12-SB	12 x 3	5.62	1.5
15-SB	15 x 3	6.56	2.0
18-SB	18 x 3	7.24	2.0
24-SB	24 x 3	9.19	2.5
30-SB	30 x 3	10.72	3.5
36-SB	36 x 3	11.53	4.0

X STYLE SIDE BRACES



Starter/Add-On Style			
Product Number	Size	List Ea.	Shpg. Wt.
12UCB	12"D	5.55	1.5
18UCB	18"D	6.14	2.0
24UCB	24"D	6.65	2.5

CATALOG PAGE 27

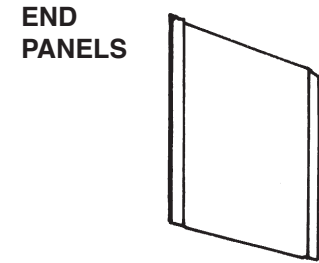

Product Number	Size D" x H"	List Each	Shpg. Wt.	Product Number	Size D" x H"	List Each	Shpg. Wt.	Product Number	Size D" x H"	List Each	Shpg. Wt.
124	12 x 49	15.22	5.0	159	15 x 109	35.48	13.0	247	24 x 85	40.04	17.5
125	12 x 61	17.04	6.0	1510	15 x 121	39.68	15.0	248	24 x 97	46.51	19.0
126	12 x 73	19.12	7.0	184	18 x 49	21.92	7.5	249	24 x 109	52.69	21.0
127	12 x 85	22.70	8.0	185	18 x 61	25.19	9.5	2410	24 x 121	59.27	23.0
128	12 x 97	26.30	9.0	186	18 x 73	28.53	11.0	304	30 x 49	32.49	13.0
129	12 x 109	30.18	10.0	187	18 x 85	31.49	12.5	305	30 x 61	39.31	16.0
1210	12 x 121	33.69	13.5	188	18 x 97	36.04	14.5	306	30 x 73	46.25	19.0
154	15 x 49	17.82	6.0	189	18 x 109	41.15	16.0	307	30 x 85	52.63	22.0
155	15 x 61	20.56	7.5	1810	18 x 121	47.09	18.5	308	30 x 97	59.71	25.0
156	15 x 73	23.19	9.0	244	24 x 49	29.75	10.5	309	30 x 109	66.82	28.0
157	15 x 85	26.77	10.5	245	24 x 61	34.70	13.0	3010	30 x 121	73.30	31.0
158	15 x 97	31.50	12.0	246	24 x 73	39.24	15.0				

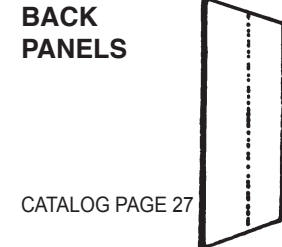

Product Number	Size W" x H"	List Each	Shpg. Wt.	Product Number	Size W" x H"	List Each	Shpg. Wt.	Product Number	Size W" x H"	List Each	Shpg. Wt.
364	36 x 49	37.46	16.0	424	42 x 49	44.18	18.0	484	48 x 49	48.78	21.0
365	36 x 61	49.33	19.5	425	42 x 61	53.92	22.0	485	48 x 61	61.37	25.5
366	36 x 73	55.74	23.0	426	42 x 73	64.00	26.0	486	48 x 73	66.12	30.5
367	36 x 85	62.21	26.5	427	42 x 85	74.76	30.0	487	48 x 85	80.42	35.0
368	36 x 97	74.22	30.0	428	42 x 97	85.52	34.0	488	48 x 97	92.08	38.0
369	36 x 109	87.91	32.5	429	42 x 109	96.86	38.0	489	48 x 109	105.61	42.0
3610	36 x 121	100.21	36.0	4210	42 x 121	106.95	44.5	4810	48 x 121	118.36	45.5



Product Number	Size W" x D"	List Each	Shpg. Wt.	Product Number	Size W" x D"	List Each	Shpg. Wt.	Product Number	Size W" x D"	List Each	Shpg. Wt.
36-12-S	36 x 12	18.25	7.0	42-12-S*	42 x 12	22.96	8.5	48-12-S	48 x 12	25.05	9.5
36-15-S	36 x 15	21.93	8.5	42-15-S*	42 x 15	26.35	9.5	48-15-S	48 x 15	28.92	11.0
36-18-S	36 x 18	24.54	9.5	42-18-S*	42 x 18	28.92	11.5	48-18-S	48 x 18	31.57	13.0
36-24-S	36 x 24	31.25	13.0	42-24-S*	42 x 24	37.48	15.0	48-24-S	48 x 24	41.52	17.0
36-30-S	36 x 30	40.25	16.0	42-30-S*	42 x 30	46.85	18.0	48-30-S	48 x 30	53.15	20.5
36-36-S	36 x 36	47.21	18.5	42-36-S*	42 x 36	54.25	21.5	48-36-S	48 x 36	61.26	24.0

*42" W shelves are flange-type only without ribs or divider holes.

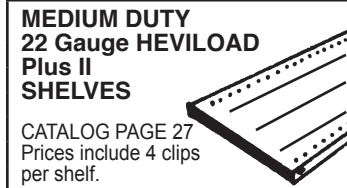

Product Number	Size W" x D"	List Each	Shpg. Wt.
902-123	36 x 12	16.63	6.0
902-183	36 x 18	22.32	8.0
902-243	36 x 24	28.40	10.0
902-124	48 x 12	22.78	8.0
902-184	48 x 18	28.74	10.5
902-244	48 x 24	37.74	13.0

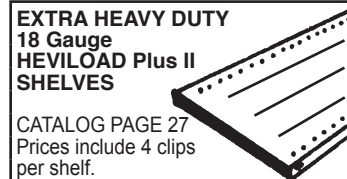

Product Number	Size W" x D"	List Each	Shpg. Wt.
802-123	36 x 12	24.76	9.5
802-183	36 x 18	32.45	12.8
802-243	36 x 24	40.58	16.0
802-124	48 x 12	33.04	12.5
802-184	48 x 18	40.88	16.5
802-244	48 x 24	53.05	20.8

ULTRACAP SHELVES

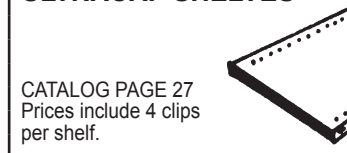

Size W" x D"	24 Gauge			22 Gauge			20 Gauge		
	Product #	List Ea.	Wt.	Product #	List Ea.	Wt.	Product #	List Ea.	Wt.
36 x 12	UCS5420	18.12	5.5	UCS5220	19.07	7.0	UCS5020	23.51	8.0
36 x 18	UCS5430	23.26	7.0	UCS5230	24.97	8.5	UCS5030	30.85	10.0
36 x 24	UCS5440	28.60	9.0	UCS5240	30.07	11.5	UCS5040	38.52	13.5
48 x 12	UCS5450	24.38	7.0	UCS5250	26.26	8.5	UCS5050	31.36	10.0
48 x 18	UCS5460	34.02	9.0	UCS5260	35.82	11.5	UCS5060	38.88	13.5
48 x 24	UCS5470	40.92	12.0	UCS5270	43.07	15.0	UCS5070	50.39	17.5

**CLASS
A**



STANDARD SHELVING ACCESSORIES

(Industrial Gray only)



CATALOG PAGES 26 & 27

DIVIDERS

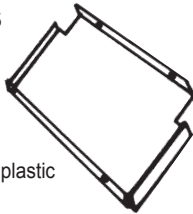

CATALOG
PAGE 27
Prices include plastic
"snap-in" clips.

Product Number	Size D" x H"	List Each	Shpg. Wt.	Product Number	Size D" x H"	List Each	Shpg. Wt.	Product Number	Size D" x H"	List Each	Shpg. Wt.
126-D	12 x 6	3.56	.5	159-D	15 x 9	5.90	1.0	1812-D	18 x 12	8.05	1.5
129-D	12 x 9	5.20	1.0	1512-D	15 x 12	6.87	1.5	1818-D	18 x 18	11.53	2.0
1212-D	12 x 12	5.62	1.0	1518-D	15 x 18	8.79	2.0	246-D	24 x 6	6.14	1.0
1218-D	12 x 18	7.75	1.5	186-D	18 x 6	4.72	1.0	249-D	24 x 9	8.53	1.5
156-D	15 x 6	4.72	.5	189-D	18 x 9	6.50	1.5	2412-D	24 x 12	9.84	2.0
								2418-D	24 x 18	14.27	3.0

LABEL HOLDER

CATALOG
PAGE 27



Product Number	Product Size W" x H"	List Price Each Item	Approx. Shpg. Wt.
30-LH	30 x 1	1.46	.5
36-LH	36 x 1	1.98	.5
42-LH	42 x 1	2.66	.5
48-LH	48 x 1	3.60	.5

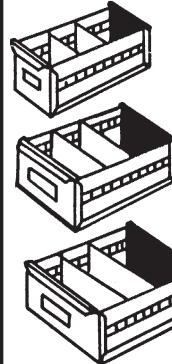

Shelf Drawers* - Packed 12 per carton.

Product Number	Size W" x D" x H"	List Price Each Item	Approx. Shpg. Wt.
270-121	5 ⁹ / ₁₆ x 11 ³ / ₄ x 4 ⁵ / ₈	15.29	2
270-181	5 ⁹ / ₁₆ x 17 ³ / ₄ x 4 ⁵ / ₈	17.93	3
280-121	8 ³ / ₈ x 11 ³ / ₄ x 4 ⁵ / ₈	22.15	3
280-181	8 ³ / ₈ x 17 ³ / ₄ x 4 ⁵ / ₈	26.36	4
290-121	11 ¹ / ₄ x 11 ³ / ₄ x 4 ⁵ / ₈	26.98	4
290-181	11 ¹ / ₄ x 17 ³ / ₄ x 4 ⁵ / ₈	30.69	5

Dividers* - Packed 50 per carton.

Product Number	Size W" x H"	List Price Each Item	Approx. Shpg. Wt.
270-01	5 ⁹ / ₁₆ x 4 ⁵ / ₈	1.45	.5
280-01	8 ³ / ₈ x 4 ⁵ / ₈	2.66	.5
290-01	11 ¹ / ₄ x 4 ⁵ / ₈	3.50	.5

*Must order in complete carton quantities.

GUSSET BRACE

CATALOG
PAGE 27

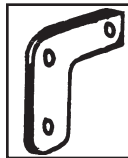

Product Number	Actual Product Size W" x L"	List Price Each Item	Approx. Shpg. Wt.
5-GB	5 x 5	1.23	1.0

BASE STRIP

CATALOG
PAGE 27



Product Number	Size W" x H"	List Price Each Item	Approx. Shpg. Wt.
----------------	--------------	----------------------	-------------------

HeviLoad

3015-B	30 x 17 ⁵ / ₈	4.72	1.5
3615-B	36 x 17 ⁵ / ₈	5.74	1.5
4215-B	42 x 17 ⁵ / ₈	6.43	2.0
4815-B	48 x 17 ⁵ / ₈	7.26	2.0

Ultra Cap

3615UCB	36 x 17 ⁵ / ₈	5.74	1.5
4815UCB	48 x 17 ⁵ / ₈	7.26	2.0

BIN FRONT

CATALOG
PAGE 27



Product Number	Size W" x H"	List Price Each Item	Approx. Shpg. Wt.
HeviLoad			
3015-F	30 x 1 ¹ / ₂	5.74	2.0
3615-F	36 x 1 ¹ / ₂	6.38	2.5
4215-F	42 x 1 ¹ / ₂	7.54	3.0
4815-F	48 x 1 ¹ / ₂	8.53	3.0
303-F	30 x 3	5.90	2.5
363-F	36 x 3	7.36	3.0
423-F	42 x 3	8.62	3.5
483-F	48 x 3	9.59	4.0
Ultra Cap			
3615UCF	36 x 1 ¹ / ₂	6.38	2.5
4815UCF	48 x 1 ¹ / ₂	8.53	3.0
363UCF	36 x 3	7.36	3.0
483UCF	48 x 3	9.59	4.0

REINFORCING BAR FOR HEVILOAD & FEATURE LINE ONLY

CATALOG
PAGE 27 & 34



Product Number	Product Size Width	List Price Each Item	Approx. Shpg. Wt.
24-RB	24	3.72	2.0
30-RB	30	4.66	2.5
36-RB	36	5.47	3.0
42-RB	42	5.99	3.5
48-RB	48	6.74	4.0

MEZZANINE BRACKETS

CATALOG
PAGE 7

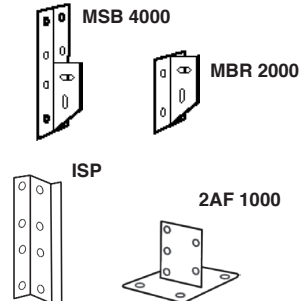

Product Number	Description	List Price Each	Approx. Shpg. Wt.
MBR 1000	Single Post Mezzanine Bracket	5.52	1.0
MBR 2000	Double Post Mezzanine Bracket	10.99	2.0
MSB 3000	Single Post Mezzanine Splicer/Bracket	7.45	1.5
MSB 4000	Double Post Mezzanine Splicer/Bracket	14.91	2.5
ISP	Industrial Splice Plate	1.93	1.0
2AF 1000	Floor Anchor Bracket	3.50	0.5

**CLASS
A**

EXTRA HEAVY DUTY SHELVING



CATALOG PAGE 29

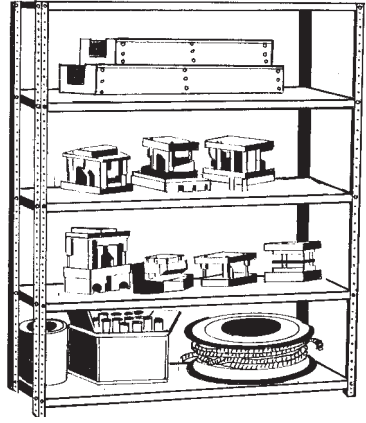

Complete Units

Product Number	Dimensions W" x D" x H"	Number of Shelves	List Price Each	Shpg. Wt. Lbs.
1250	36 x 18 x 72	5	448.81	167
1251	48 x 18 x 72	5	578.36	212
1252	60 x 18 x 72	5	678.87	252
1253	36 x 24 x 72	5	554.38	197
1254	48 x 24 x 72	5	624.30	242
1255	60 x 24 x 72	5	831.38	292
1262	72 x 24 x 72	5	1,021.78	342
1256	36 x 18 x 96	5	467.92	175
1257	48 x 18 x 96	5	597.47	220
1258	60 x 18 x 96	5	698.00	260
1259	36 x 24 x 96	5	573.51	205
1260	48 x 24 x 96	5	643.42	250
1261	60 x 24 x 96	5	850.48	300
1263	72 x 24 x 96	5	1,040.87	350

Components

Product Number	Dimensions	List Price Ea.	Shpg. Wt. Lbs.
1200-P	72" Post	18.31	8
1210-P	84" Post	20.77	9
1201-P	96" Post	23.07	10
1202-S	36"W x 18"D Shelf	75.10	27
1203-S	48"W x 18"D Shelf	101.04	36
1204-S	60"W x 18"D Shelf	121.13	44
1205-S	36"W x 24"D Shelf	96.22	33
1206-S	48"W x 24"D Shelf	110.21	42
1207-S	60"W x 24"D Shelf	151.63	52
1208-S*	72"W x 24"D Shelf	189.71	62

* Packed One Per Carton.
All other shelves packed 5 per carton.

**CLASS
B**

FEATURE LINE SHELVING



Commercial Grade - Open & Closed

CATALOG PAGES 30 & 31

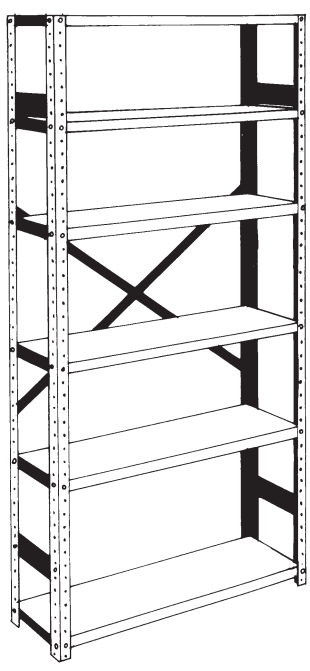

OPEN STYLE
CATALOG PAGE 30

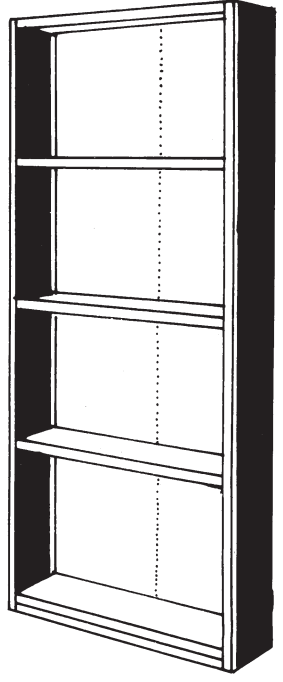

CLOSED STYLE
CATALOG PAGE 31

Open Style — CATALOG PAGE 30

Gray Product Number	Tan Product Number	Product Size (Inches) W" x D" x H"	List Price Each Item	Approx. Shpg. Wt. (Lbs.)
2912-5	2912-5TN	36 x 12 x 75	104.43	47.0
2915-5	2915-5TN	36 x 15 x 75	117.05	54.0
2918-5	2918-5TN	36 x 18 x 75	133.23	60.0
2924-5	2924-5TN	36 x 24 x 75	168.40	66.0
2912-6	2912-6TN	36 x 12 x 75	117.05	52.5
2915-6	2915-6TN	36 x 15 x 75	131.88	60.5
2918-6	2918-6TN	36 x 18 x 75	150.26	67.5
2924-6	2924-6TN	36 x 24 x 75	191.86	74.5
2912-8	2912-8TN	36 x 12 x 85	149.65	66.0
2918-8	2918-8TN	36 x 18 x 85	190.54	83.0
2924-8	2924-8TN	36 x 24 x 85	242.96	100.0

Standard Color is GRAY. For TAN units add TN suffix to product number.

Closed Style — CATALOG PAGE 31

Gray Product Number	Tan Product Number	Product Size (Inches) W" x D" x H"	List Price Each Item	Approx. Shpg. Wt. (Lbs.)
2912-5CL	2912-5CLTN	36 x 12 x 75	185.58	84.0
2915-5CL	2915-5CLTN	36 x 15 x 75	204.39	95.0
2918-5CL	2918-5CLTN	36 x 18 x 75	229.81	105.0
2924-5CL	2924-5CLTN	36 x 24 x 75	281.94	120.0
2912-6CL	2912-6CLTN	36 x 12 x 75	198.21	89.0
2915-6CL	2915-6CLTN	36 x 15 x 75	219.20	101.0
2918-6CL	2918-6CLTN	36 x 18 x 75	246.83	113.0
2924-6CL	2924-6CLTN	36 x 24 x 75	305.41	128.0
2912-8CL	2912-8CLTN	36 x 12 x 85	252.58	98.0
2918-8CL	2918-8CLTN	36 x 18 x 85	310.02	122.0
2924-8CL	2924-8CLTN	36 x 24 x 85	378.29	146.0

Standard Color is GRAY. For TAN units add TN suffix to product number.

Extra Shelves

S-12*	S-12TN*	36 x 12	12.80	5.5
S-15*	S-15TN*	36 x 15	15.36	6.5
S-18*	S-18TN*	36 x 18	17.58	7.5
S-24*	S-24TN*	36 x 24	23.41	8.5

*Shelves packed 4 to a carton. Must order in complete carton quantities. Standard Color GRAY. For TAN shelves add TN suffix to product number.

(NOTE: Standard Color is GRAY.
For TAN units or shelves,
add TN suffix to product number.
For shelf reinforcements, see Price Manual-Page 14.)

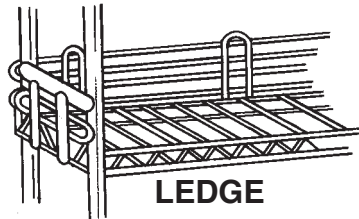
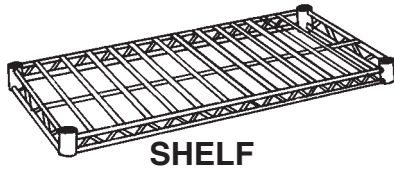
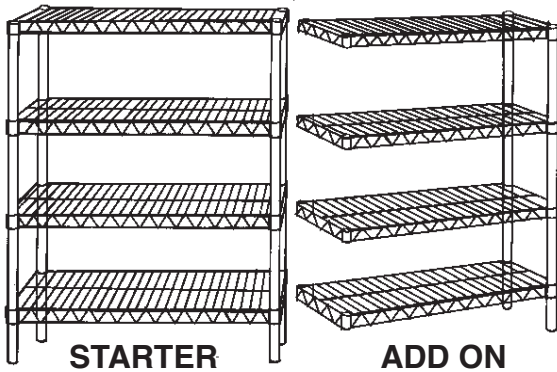

EXTRA POSTS

Product Number	Height	List Price Each	Shpg. Wt. (Lbs.)
WS P73	63"	-	3
WS P74	74"	27.83	4
WS P86	86"	33.40	5

STARTER: 4 SHELVES

Product Number	Size W" x D" x H"	List Price	Shpg. Wt. (Lbs.)
WS600	36x18x63	-	52
WS601	48x18x63	-	62
WS602	60x18x63	-	92
WS603	72x18x63	-	102
WS604	36x24x63	-	66
WS605	48x24x63	-	78
WS606	60x24x63	-	98
WS607	72x24x63	-	118

ADD ON: 4 SHELVES

Product Number	Size W" x D" x H"	List Price	Shpg. Wt. (Lbs.)
WS608	36x18x63	-	46
WS609	48x18x63	-	56
WS610	60x18x63	-	75
WS611	72x18x63	-	87
WS612	36x24x63	-	58
WS613	48x24x63	-	72
WS614	60x24x63	-	91
WS615	72x24x63	-	113

WS616	36x18x74	377.34	54
WS617	48x18x74	432.27	64
WS618	60x18x74	487.23	84
WS619	72x18x74	564.18	96
WS620	36x24x74	443.28	68
WS621	48x24x74	509.23	80
WS622	60x24x74	-	100
WS623	72x24x74	677.76	120

WS624	36x18x74	331.30	47
WS625	48x18x74	385.59	57
WS626	60x18x74	439.85	76
WS627	72x18x74	515.80	88
WS628	36x24x74	396.43	59
WS629	48x24x74	461.54	73
WS630	60x24x74	-	92
WS631	72x24x74	630.78	114

WS632	36x18x86	399.30	58
WS633	48x18x86	454.24	68
WS634	60x18x86	509.23	88
WS635	72x18x86	586.16	100
WS636	36x24x86	465.24	72
WS637	48x24x86	531.23	84
WS638	60x24x86	-	104
WS639	72x24x86	699.72	124

WS640	36x18x86	342.16	49
WS641	48x18x86	396.43	59
WS642	60x18x86	450.69	78
WS643	72x18x86	526.67	90
WS644	36x24x86	407.26	61
WS645	48x24x86	472.40	75
WS646	60x24x86	-	94
WS647	72x24x86	641.92	116

EXTRA SHELVES

Product Number	Size W" x D"	List Price Each	Shpg. Wt. (Lbs.)
WS648	36x18	67.70	38
WS649	48x18	81.62	48
WS650	60x18	95.52	68
WS651	72x18	115.02	80
WS652	36x24	84.40	52
WS653	48x24	101.11	64
WS654	60x24	-	84
WS655	72x24	143.76	104
WS Clips		1.71	54

LEDGES

Product Number	Size W" x D"	List Price	Shpg. Wt. (Lbs.)
WS656	18"	13.54	1
WS657	24"	16.91	2
WS658	36"	23.14	3
WS659	48"	28.92	4
WS660	60"	31.42	4
WS661	72"	37.62	5

CASTERS (SET OF 4)

WSCAK	---	120.63	10
-------	-----	--------	----

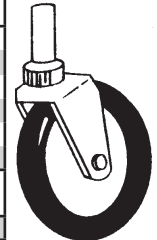

Shelves packed 4 per carton. Must order in complete carton quantities.

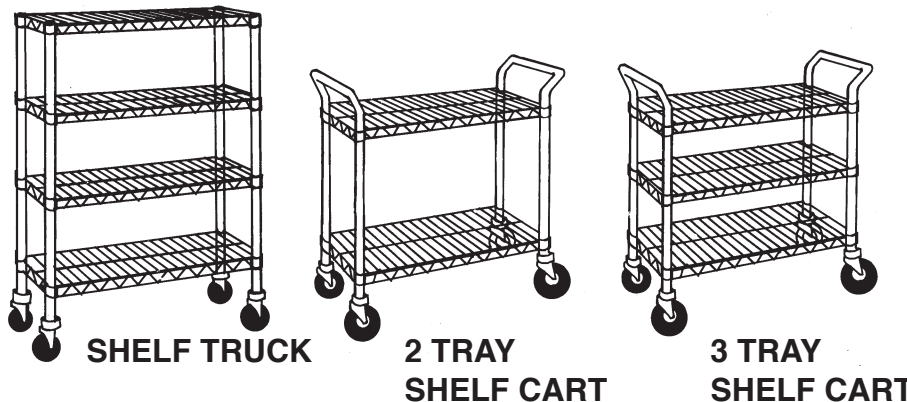

Product Number	Size W" x D"	List Price	Shpg. Wt. (Lbs.)
MOBILE SHELF TRUCK			
WS662	36x18x68	495.05	62
WS663	48x18x68	552.17	72
WS664	60x18x68	609.29	92
WS665	72x18x68	689.27	104
WS666	36x24x68	563.60	76
WS667	48x24x68	632.12	88
WS668	60x24x68	723.54	100
WS669	72x24x68	807.30	128

Product Number	Size W" x D"	List Price	Shpg. Wt. (Lbs.)
HEAVY DUTY UTILITY CART			
WS670	36x18-2tray	319.75	42
WS671	48x18-2tray	348.66	44
WS672	36x24-2tray	361.46	50
WS673	48x24-2tray	395.69	56
WS674	36x18-3tray	386.58	52
WS675	48x18-3tray	429.24	54
WS676	36x24-3tray	444.83	63
WS677	48x24-3tray	495.51	72

CLASS E

SLOTTED ANGLE



CATALOG PAGES 34 & 35

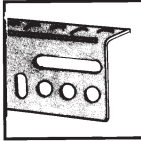

14 GA

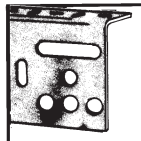

12 GA

Product Number	Length	Size	Qty. Per Bundle	List Price Per Bundle	Shpg. Wt. (Lbs.)
14 GAUGE - GALVANIZED					
SA21005	10'	2 1/4" x 1 1/2"	5	130.64	42
SA21010	10'	2 1/4" x 1 1/2"	10	261.34	84
SA21205	12'	2 1/4" x 1 1/2"	5	155.43	50
SA21210	12'	2 1/4" x 1 1/2"	10	310.80	100
12 GAUGE - GALVANIZED					
SA31005	10'	3" x 1 1/2"	5	192.23	66
SA31010	10'	3" x 1 1/2"	10	384.45	133
SA31205	12'	3" x 1 1/2"	5	229.56	80
SA31210	12'	3" x 1 1/2"	10	459.13	160

Product Number	Length	Size	Qty. Per Bundle	List Price Per Bundle	Shpg. Wt. (Lbs.)
14 GAUGE - PAINTED					
SAP14-105	10'	2 1/4" x 1 1/2"	5	111.69	56.5
SAP14-1010	10'	2 1/4" x 1 1/2"	10	223.34	113.0
SAP14-125	12'	2 1/4" x 1 1/2"	5	130.42	61.5
SAP14-1210	12'	2 1/4" x 1 1/2"	10	260.81	123.0
12 GAUGE - PAINTED					
SAP12-105	10'	3" x 1 1/2"	5	161.68	81.5
SAP12-1010	10'	3" x 1 1/2"	10	323.32	163.0
SAP12-125	12'	3" x 1 1/2"	5	192.61	101.5
SAP12-1210	12'	3" x 1 1/2"	10	385.21	203.0

ACCESSORIES

Product #	Description	Size	Qty.	List Price	Wt. (Lbs.)
SAC1	Cutter	--	1	643.34	14
FAS75	Nuts and Bolts	3/8" -- 16 x 3/4"	75	11.32	3
GP10	Gusset Plates	6" x 6"	10	33.99	5
SAC5S	Swivel Casters	5" x 1 1/4"	1	15.68	1
SAC5R	Rigid Casters	5" x 1 1/4"	1	13.77	1
SAC5SB	Swivel Caster w/Brake	5" x 1 1/4"	1	18.57	2

CLASS B

PLASTIC SHELF BOXES WITH SHELVING



CATALOG PAGE 36

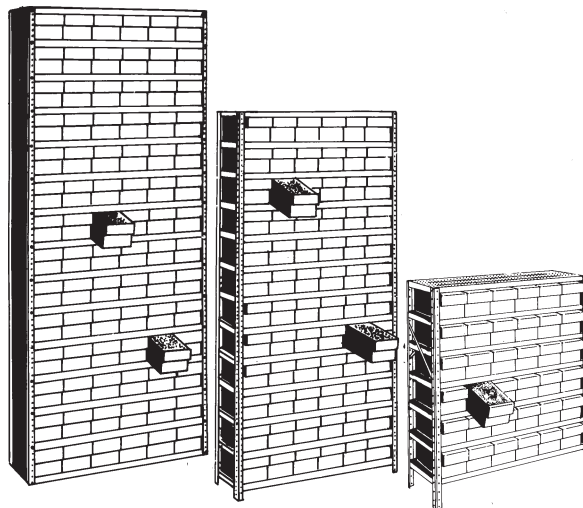

COMMERCIAL SHELVING

Product Number	Style	No. of Shelves	W" x D" x H"	No. of Bins	Bin Size W" x D" x H"	List Price Each	Shpg. Wt. Lbs.
PSB6500	Open	7	36 x 12 x 42	36	5 1/16 x 11 3/4 x 4 5/8	331.28	55
PSB6501	Open	7	36 x 12 x 42	24	8 3/8 x 11 3/4 x 4 5/8	314.35	58
PSB6512	Open	7	36 x 18 x 42	36	5 1/16 x 17 3/4 x 4 5/8	426.58	79
PSB6513	Open	7	36 x 18 x 42	24	8 3/8 x 17 3/4 x 4 5/8	399.98	81
PSB6502	Open	13	36 x 12 x 75	72	5 1/16 x 11 3/4 x 4 5/8	675.83	145
PSB6503	Open	13	36 x 18 x 75	72	5 1/16 x 17 3/4 x 4 5/8	892.46	204
PSB6504	Open	13	36 x 12 x 75	48	8 3/8 x 11 3/4 x 4 5/8	642.01	151
PSB6505	Open	13	36 x 18 x 75	48	8 3/8 x 17 3/4 x 4 5/8	839.26	208
PSB6506	Open	13	36 x 12 x 75	60	(36) 5 1/16 x 11 3/4 x 4 5/8 (24) 8 3/8 x 11 3/4 x 4 5/8	658.91	148
PSB6507	Open	13	36 x 18 x 75	60	(36) 5 1/16 x 17 3/4 x 4 5/8 (24) 8 3/8 x 17 3/4 x 4 5/8	865.86	206

INDUSTRIAL SHELVING

Product Number	Style	No. of Shelves	W" x D" x H"	No. of Bins	Bin Size W" x D" x H"	List Price Each	Shpg. Wt. Lbs.
PSB6508	Open	15	36 x 12 x 85	84	5 1/16 x 11 3/4 x 4 5/8	896.13	201
PSB6509	Open	15	36 x 18 x 85	84	5 1/16 x 17 3/4 x 4 5/8	1,168.66	273
PSB6510	Open	15	36 x 12 x 85	72	(48) 5 1/16 x 11 3/4 x 4 5/8 (24) 8 3/8 x 11 3/4 x 4 5/8	879.21	204
PSB6511	Open	15	36 x 18 x 85	72	(48) 5 1/16 x 17 3/4 x 4 5/8 (24) 8 3/8 x 17 3/4 x 4 5/8	1,142.08	275
PSB6514	Closed	15	36 x 12 x 85	84	5 1/16 x 11 3/4 x 4 5/8	992.52	244
PSB6515	Closed	15	36 x 18 x 85	84	5 1/16 x 17 3/4 x 4 5/8	1,279.46	325

CLASS B

PICK RACKS, PLASTIC SHELF BOXES



CATALOG PAGE 37

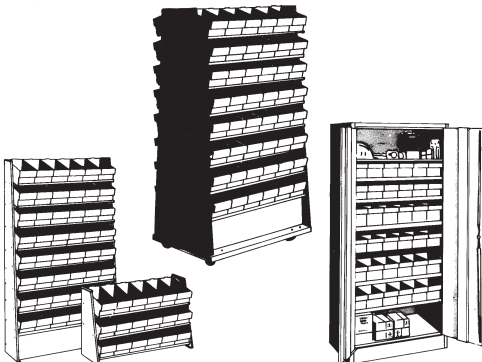

PICK RACKS WITH PLASTIC SHELF BOXES

Product #	Style	Tiers	W" x D" x H"	No. of Bins	Bin Size W" x D" x H"	List Price Ea.	Wt. Lbs.
PR6550	Bench	3	33 1/2 x 12 x 21 1/2	18	5 1/16 x 11 3/4 x 4 5/8	218.07	36
PR6551	Bench	3	33 1/2 x 12 x 21 1/2	12	8 3/8 x 11 3/4 x 4 5/8	209.61	39
PR6552	Floor	8	33 1/2 x 12 x 61	48	5 1/16 x 11 3/4 x 4 5/8	546.67	67
PR6553	Floor	8	33 1/2 x 12 x 61	36	(12) 5 1/16 x 11 3/4 x 4 5/8 (24) 8 3/8 x 11 3/4 x 4 5/8	529.73	82
PR6554	Mobile	16	36 x 26 x 65	96	5 1/16 x 11 3/4 x 4 5/8	1,233.66	151
PR6555	Mobile	16	36 x 26 x 65	72	(24) 5 1/16 x 11 3/4 x 4 5/8 (48) 8 3/8 x 11 3/4 x 4 5/8	1,199.81	166

ALL STEEL STORAGE CABINET WITH BOXES

Product Number	Style	No. of Shelves	W" x D" x H"	No. of Bins	Bin Size W" x D" x H"	List Price Each	Shpg. Wt. Lbs.
PR6556	Cabinet	7	36 x 18 x 78	36	5 1/16 x 11 3/4 x 4 1/4	851.36	186

**CLASS
B**

HEAVY DUTY PLASTIC SHELF BOXES

CATALOG PAGE 37

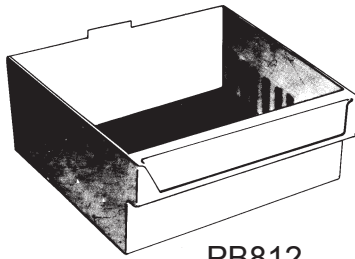

PB812

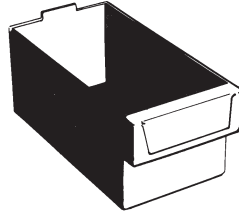

PB512



HEAVY DUTY PLASTIC SHELF BOXES*

Product Number	W" x D" x H"	List Price Each	Shpg. Wt. Lbs.
PB512	5 ⁵ / ₁₆ x 11 ³ / ₄ x 4 ⁵ / ₈	6.52	9
PB518	5 ⁵ / ₁₆ x 17 ³ / ₄ x 4 ⁵ / ₈	8.60	14
PB812	8 ³ / ₈ x 11 ³ / ₄ x 4 ⁵ / ₈	9.06	15
PB818	8 ³ / ₈ x 17 ³ / ₄ x 4 ⁵ / ₈	11.77	22

DIVIDERS**

Product Number	W" x D" x H"	List Price Each	Shpg. Wt. Lbs.
PBD5	5 ⁷ / ₁₆ x 4 ⁷ / ₈	-	5
PBD8	8 ³ / ₈ x 4 ⁵ / ₈	-	6

*Plastic Shelf Boxes are packed 12 per carton. **Plastic Shelf Box Dividers are packed 50 per carton. Must order in complete quantities.

**CLASS
B**

SHELVING/PICK RACKS

WITH PLASTIC BINS



CATALOG PAGE 38

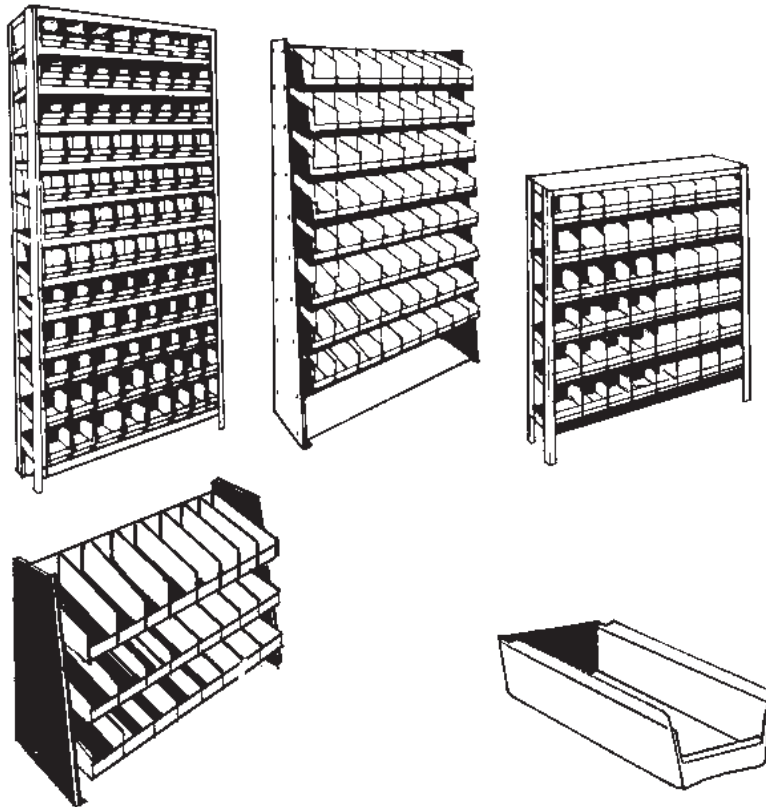

13 SHELF UNIT/PLASTIC BINS

Product Number	Qty. Bins	Dimensions W" x D" x H"		List Price Each	Shpg. Wt. Lbs.
		Bins	Shelving		
PB 306	(96)	4 x 12 x 4	36 x 12 x 75	488.92	90
PB 307	(96)	4 x 18 x 4	36 x 18 x 75	676.53	135
PB 308	(48)	8 x 12 x 4	36 x 12 x 75	416.44	92
PB 309	(24)	8 x 12 x 4	36 x 12 x 75	452.66	91
	(48)	4 x 12 x 4			

7 SHELF UNIT/PLASTIC BINS

PB 310	(48)	4 x 12 x 4	36 x 12 x 42	237.81	36
PB 311	(24)	8 x 12 x 4	36 x 12 x 42	201.55	37

3 SHELF PICK RACK/PLASTIC BINS

PB 312	(24)	4 x 12 x 4	36 x 12 x 22	171.35	32
PB 313	(12)	8 x 12 x 4	36 x 12 x 22	153.23	33

8 SHELF PICK RACK/PLASTIC BINS

PB 314	(64)	4 x 12 x 4	36 x 12 x 61	422.05	85
PB 315	(32)	8 x 12 x 4	36 x 12 x 61	373.70	81

MOBILE PICK RACK/PLASTIC BINS

PB 320	(96)	4 x 12 x 4	36 x 12 x 61	960.27	196
	(16)	8 x 12 x 4			

PLASTIC BINS

Product Number	Dimensions W" x D" x H"	Carton Quantity	List Price Each	Shpg. Wt. Lbs.
PB300	4" x 12" x 4"	48	2.92	16
PB301	6" x 12" x 4"	48	3.48	25
PB302	8" x 12" x 4"	24	4.36	17
PB303	4" x 18" x 4"	24	4.19	15
PB304	6" x 18" x 4"	24	5.18	20
PB305	Mini Cup	100	0.71	5

Bins Must Be Ordered In Carton Multiples Only.

**CLASS
B**

SHELVING/PICK RACKS WITH CORRUGATED BINS



CATALOG PAGE 39

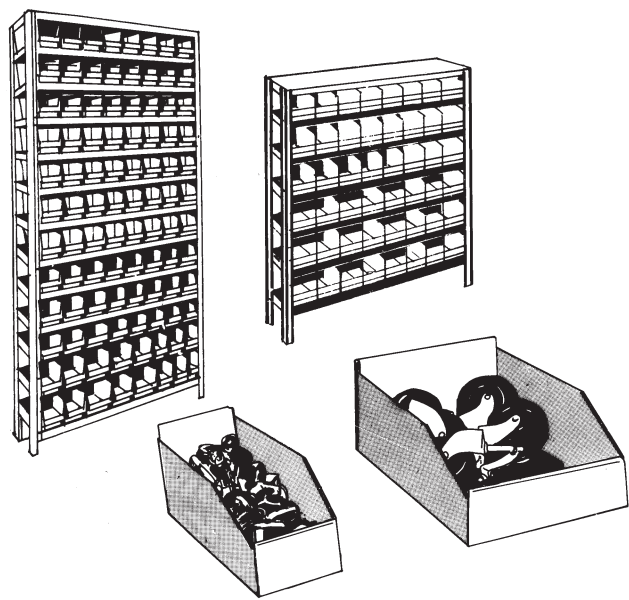

7 SHELF UNIT

Product Number	Description	Shelving W" x D" x H"	List Price Each	Shpg. Wt. Lbs.
CC40	Shelving & (32) 4"x12" Bins & (8) 8"x12" Bins	36 x 12 x 42	152.41	34
CC48	Shelving & (48) 4"x12" Bins	36 x 12 x 42	170.13	34
CC96	Shelving & (96) 2"x12" Bins	36 x 12 x 42	228.96	34

13 SHELF UNIT

Product Number	Description	Shelving W" x D" x H"	List Price Each	Shpg. Wt. Lbs.
FSC500	Shelving & (192) 2" x 12" Bins	36 x 12 x 75	471.20	138
FSC501	Shelving & (96) 4" x 12" Bins	36 x 12 x 75	353.58	104
FSC502	Shelving & (48) 8" x 12" Bins	36 x 12 x 75	302.82	104

PICK RACK

Product Number	Description	List Price Each	Shpg. Wt. Lbs.
PR-6000	33 ¹ / ₂ x 12 x 21 - 20 Bins	129.15	24
PR-6100	33 ¹ / ₂ x 12 x 61 - 56 Bins	291.18	58
PR-6200	36 x 26 x 65 - 112 Bins	722.71	142

CORRUGATED BINS

Product Number	Description	List Price Each	Shpg. Wt. Lbs.
CB212	2" x 12"	1.38	3
CB412	4" x 12"	1.53	5
CB812	8" x 12"	2.02	13
CBM1	Mini Cups	0.71	5

All Bins 48 Per Carton. 100 Mini Cups Per Carton. Must Be Ordered In Complete Carton Quantities.

**CLASS
B**

STACKABLE BINS

CATALOG PAGE 40

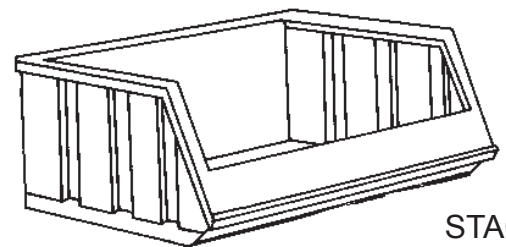

STACKABLE BIN

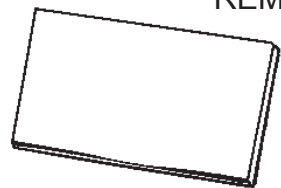

REMOVABLE DIVIDERS

STACKABLE PLASTIC SHELF BOXES

Product Number	Description W" x D" x H"	Carton Quantity	List Price Each	Shpg. Wt. Lbs.
PB 8500	4 ¹ / ₈ x 5 ³ / ₈ x 3	24	2.49	7
PB 8501	4 ¹ / ₈ x 7 ³ / ₈ x 3	24	3.06	8
PB 8502	5 ¹ / ₂ x 10 ⁷ / ₈ x 5	12	7.52	9
PB 8503	11 x 10 ⁷ / ₈ x 5	6	11.59	8
PB 8504	8 ¹ / ₄ x 14 ³ / ₄ x 7	12	14.90	18
PB 8505	16 ¹ / ₂ x 14 ³ / ₄ x 7	6	20.79	15

*Note: Add suffix Y for yellow or B for blue. If no color is specified, yellow will be shipped. Orders must be complete carton quantities.

REMOVABLE DIVIDERS

Product Number	Description W" x D" x H"	Carton Quantity	List Price Each	Shpg. Wt. Lbs.
PBD 8506	PB 8500	6	1.25	1
PBD 8507	PB 8501	6	1.33	1
PBD 8508	PB 8502 & PB 8503	6	2.23	1
PBD 8509	PB 8504 & PB 8505	6	3.22	1

Orders must be complete carton quantities.



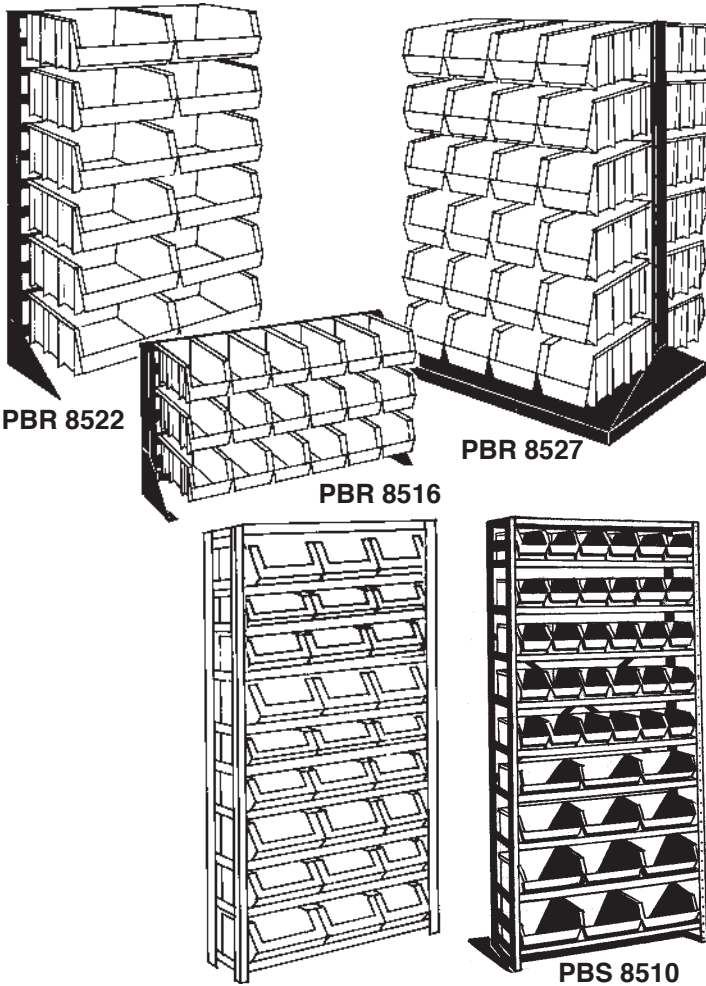

PICK RACKS

Product Number	Description W" x D" x H"	Number of Bins	List Price	Approx. Shpg. Wt.
PBR 8515	4 ¹ / ₈ x 7 ³ / ₈ x 3	32	253.87	36
PBR 8516	5 ¹ / ₂ x 10 ⁷ / ₈ x 5	18	287.71	38
PBR 8517	4 ¹ / ₈ x 5 ³ / ₈ x 3	96	513.66	94
PBR 8518	4 ¹ / ₈ x 7 ³ / ₈ x 3	96	568.43	98
PBR 8519	5 ¹ / ₂ x 10 ⁷ / ₈ x 5	48	560.41	84
PBR 8520	11 x 10 ⁷ / ₈ x 5	24	477.44	80
PBR 8521	8 ¹ / ₄ x 14 ³ / ₄ x 7	24	557.20	84
PBR 8522	16 ¹ / ₂ x 14 ³ / ₄ x 7	12	449.06	78
PBR 8523	4 ¹ / ₈ x 5 ³ / ₈ x 3	192	915.19	146
PBR 8524	4 ¹ / ₈ x 7 ³ / ₈ x 3	192	1,024.76	154
PBR 8525	5 ¹ / ₂ x 10 ⁷ / ₈ x 5	96	1,084.44	144
PBR 8526	11 x 10 ⁷ / ₈ x 5	36	918.48	136
PBR 8527	8 ¹ / ₄ x 14 ³ / ₄ x 7	48	1,078.00	144
PBR 8528	16 ¹ / ₂ x 14 ³ / ₄ x 7	24	861.68	132

*Must order in complete carton quantities.

BIN STORAGE SYSTEMS

Product Number	Qty. Bins	Dimensions		List Price	Shpg. Wt. Lbs.
		Bins	Shelving		
PBS 8510	12	8 ¹ / ₄ x 14 ³ / ₄ x 7	36" x 12" x 75"	617.87	120
	36	5 ¹ / ₂ x 10 ⁷ / ₈ x 5			
PBS 8511	36	5 ¹ / ₂ x 10 ⁷ / ₈ x 5	36" x 12" x 75"	563.78	117
	6	16 ¹ / ₂ x 14 ³ / ₄ x 7			
PBS 8512	18	11 x 10 ⁷ / ₈ x 5	36" x 12" x 75"	557.25	117
	24	5 ¹ / ₂ x 10 ⁷ / ₈ x 5			
PBS 8513	36	8 ¹ / ₄ x 14 ³ / ₄ x 7	36" x 12" x 75"	704.89	99
PBS 8514	18	16 ¹ / ₂ x 14 ³ / ₄ x 7	36" x 15" x 75"	567.65	132

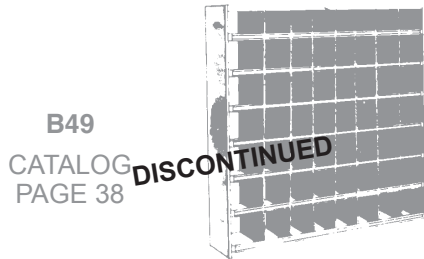

B49
CATALOG
PAGE 38

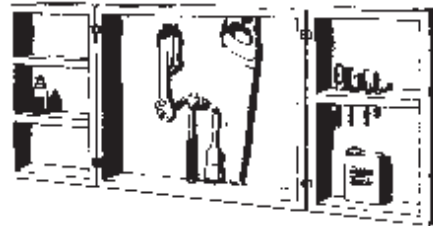

WC-1
CATALOG
PAGE 38

STACKABLE PLASTIC SHELF BOXES

Product Number	Product Size W" x D" x H"	List Price Each Item	Approx. Shpg. Wt.
B49	34 ³ / ₄ x 9 x 37 ¹ / ₂ (Unit) 4 x 8 ³ / ₄ x 5 ¹ / ₄ (ea. of 56 Compartments)	-	60.0
WC-1	30 x 11 ¹ / ₂ x 24 (Closed) 60 x 6 x 24 (Open)	144.84	27.0

**CLASS
B**

LOUVERED PANELS



CATALOG PAGE 42

LPA 50

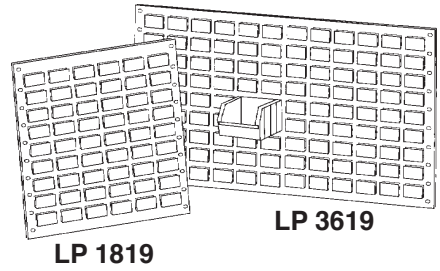
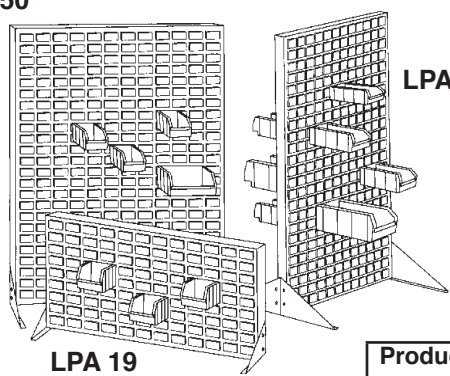

Plastic bins not included.
See Price Manual - Page 19.

Product Number	Description	Dimensions	List Each	Weight Each
LPA50	Single Sided Louvered Panel Pick Rack	36" W x 50" H	164.59	50.0
LPA25	2 Sided Conversion Kit	36" W x 50" H	142.07	40.0
LPA19	Bench Top Louvered Panel Pick Rack	36" W x 22" H	94.29	25.0
LP1819	Louvered Wall Panel (available in 4 packs only)	18" W x 19" H	25.69	25.0
LP3619	Louvered Wall Panel (available in 4 packs only)	36" W x 19" H	46.32	50.0

**CLASS
A**

**HEAVY DUTY
BOLTLESS SHELVING** with particleboard decking



CATALOG PAGE 44



Product Number	Description	W" x D" x H"	List Each	Weight Each
UR1836	5 Shelf Particleboard	36" x 18" x 72"	152.18	92.0
UR2436	5 Shelf Particleboard	36" x 24" x 72"	171.31	111.0
UR1848	5 Shelf Particleboard	48" x 18" x 72"	175.60	115.0
UR2448	5 Shelf Particleboard	48" x 24" x 72"	200.20	139.0
UR1860	5 Shelf Particleboard	60" x 18" x 72"	202.31	137.0
UR2460	5 Shelf Particleboard	60" x 24" x 72"	223.31	166.0
UR3660	5 Shelf Particleboard	60" x 36" x 72"	271.84	225.0
UR1872	5 Shelf Particleboard	72" x 18" x 72"	222.08	160.0
UR2472	5 Shelf Particleboard	72" x 24" x 72"	249.45	194.0
UR3672	5 Shelf Particleboard	72" x 36" x 72"	305.18	262.0

**CLASS
A**

MAXI-RACK



CATALOG PAGE 45

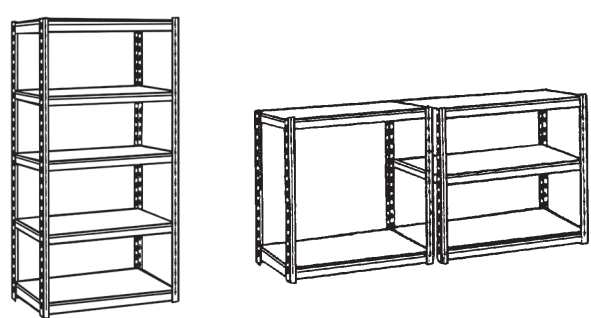

Product #	Size W" x D" x H"	Shelves	Color	List Each	Wt.
MR-185	36"x18"x72"	5	Gray	177.59	74.0
MR-2	36"x24"x72"	5	Gray	199.56	94.0
MR-1848	48"x18"x72"	5	Gray	201.17	103.0
MR-245	48"x24"x72"	5	Gray	230.46	104.0
UR-60	60"x18"x72"	5	Tan	233.22	120.0

**CLASS
A**

RIVET LOCK BOLTLESS STORAGE RACKS



CATALOG PAGES 46 & 47

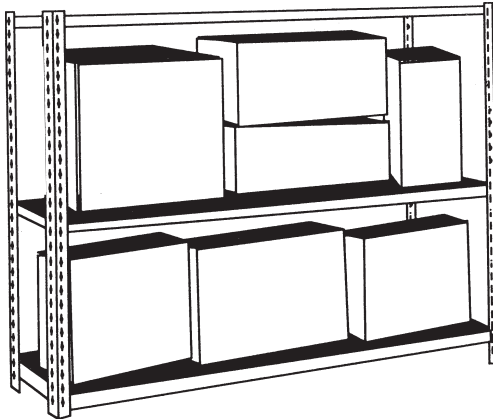

**Rivet Lock Boltless Storage Rack
3-Levels - Less Deck**

Product Number	Size W x D	List Price Each	Shpg. Wt. (Lbs.)
----------------	------------	-----------------	------------------

Rivet Lock Boltless Storage "L" Angle Beam Standard 3 Levels. 7' High.

RL2400	48" x 24"	168.13	62
RL2403	48" x 36"	182.38	68
RL2406	48" x 48"	195.30	74
RL2450	60" x 24"	186.62	72
RL2451	60" x 36"	200.76	78
RL2452	60" x 48"	213.51	84
RL2401	72" x 24"	196.62	74
RL2404	72" x 36"	210.91	80
RL2407	72" x 48"	223.78	86
RL2402	96" x 24"	224.40	86
RL2405	96" x 36"	238.63	92
RL2408	96" x 48"	251.52	98

Rivet Lock Boltless Storage "C" Channel Beam Extra Heavy Duty. 7' High.

RL2417	96" x 24"	253.90	98
RL2418	96" x 36"	268.12	104
RL2419	96" x 48"	281.04	110

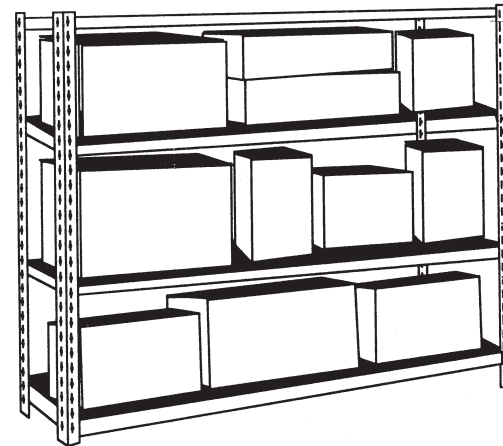

**Rivet Lock Boltless Storage Rack
4-Levels - Less Deck**

Product Number	Size W x D	List Price Each	Shpg. Wt. (Lbs.)
----------------	------------	-----------------	------------------

Rivet Lock Boltless Storage "L" Angle Beam Standard 4 Levels. 7' High.

RL2435	48" x 24"	203.75	74
RL2436	48" x 36"	222.70	82
RL2437	48" x 48"	239.81	90
RL2438	60" x 24"	222.08	88
RL2439	60" x 36"	240.74	96
RL2440	60" x 48"	257.39	104
RL2441	72" x 24"	241.59	90
RL2442	72" x 36"	260.60	98
RL2443	72" x 48"	277.69	106
RL2444	96" x 24"	279.56	106
RL2445	96" x 36"	298.53	114
RL2446	96" x 48"	315.65	122

Rivet Lock Boltless Storage "C" Channel Beam Extra Heavy Duty. 7' High.

RL2447	96" x 24"	319.38	122
RL2448	96" x 36"	338.30	130
RL2449	96" x 48"	355.47	138

Deck not included. See below for wire or particleboard decking.

**CLASS
A**

WIRE & PARTICLEBOARD SHELF DECKING



CATALOG PAGE 47



Product Number	Size W" x D"	List Each	Shpg. Wt.
RWD 2448	48 x 24	83.57	13
RWD 3648	48 x 36	111.22	19
RWD 4848	48 x 48	142.19	27
RWD 2460	60 x 24	100.77	16
RWD 3660	60 x 36	136.45	23
RWD 4860	60 x 48	173.53	34
RWD 2472	72 x 24	117.94	20
RWD 3672	72 x 36	161.72	25
RWD 4872	72 x 48	204.87	39
RWD 2496	96 x 24	167.14	26
RWD 3696	96 x 36	222.41	38
RWD 4896	96 x 48	284.38	54



Product Number	Size W" x D"	List Each	Shpg. Wt.
RLPB 2448	48 x 24	21.41	20
RLPB 3648	48 x 36	32.00	29
RLPB 4848	48 x 48	42.60	39
RLPB 2460	60 x 24	26.72	25
RLPB 3660	60 x 36	40.12	37
RLPB 4860	60 x 48	53.51	49
RLPB 2472	72 x 24	32.00	29
RLPB 3672	72 x 36	48.02	44
RLPB 4872	72 x 48	63.93	59
RLPB 2496	96 x 24	42.16	39
RLPB 3696	96 x 36	63.93	59
RLPB 4896	96 x 48	86.03	78

**CLASS
A**

MID-PROFILE RIVET LOCK, 3 SHELF UNITS



CATALOG PAGE 48

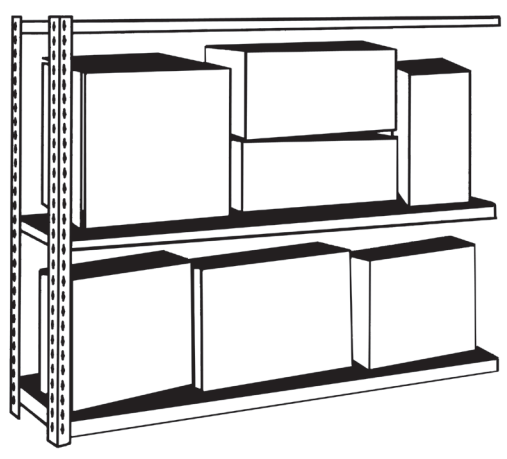
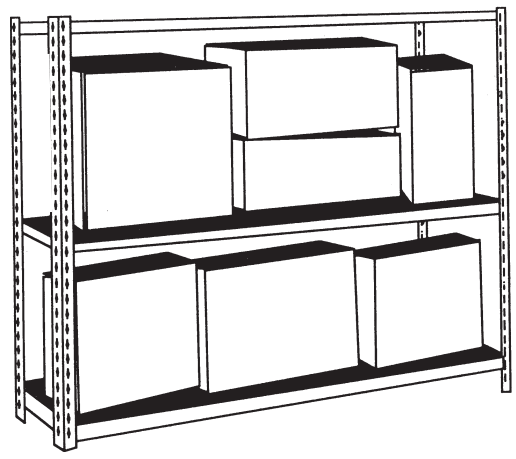

Product #	Size	List Ea.	Shpg. Wt.
-----------	------	----------	-----------

3 LEVEL STARTER UNIT - NO DECK			
RMU34824	48"W x 24"D x 84"H	184.94	58.0
RMU34836	48"W x 36"D x 84"H	200.63	64.0
RMU34848	48"W x 48"D x 84"H	214.83	70.0
RMU36024	60"W x 24"D x 84"H	205.28	64.0
RMU36036	60"W x 36"D x 84"H	220.85	70.0
RMU36048	60"W x 48"D x 84"H	234.85	76.0
RMU37224	72"W x 24"D x 84"H	238.01	79.0
RMU37236	72"W x 36"D x 84"H	262.19	88.0
RMU37248	72"W x 48"D x 84"H	284.28	97.0
RMU39624	96"W x 24"D x 84"H	290.35	100.0
RMU39636	96"W x 36"D x 84"H	322.90	112.0
RMU39648	96"W x 48"D x 84"H	353.02	124.0

3 LEVEL STARTER UNIT - PARTICLE BOARD DECK			
RMP32448	48"W x 24"D x 84"H	248.98	118.0
RMP33648	48"W x 36"D x 84"H	296.62	151.0
RMP34848	48"W x 48"D x 84"H	342.82	187.0
RMP32460	60"W x 24"D x 84"H	285.34	139.0
RMP33660	60"W x 36"D x 84"H	341.35	181.0
RMP34860	60"W x 48"D x 84"H	395.72	223.0
RMP32472	72"W x 24"D x 84"H	333.88	166.0
RMP33672	72"W x 36"D x 84"H	406.38	220.0
RMP34872	72"W x 48"D x 84"H	476.56	274.0
RMP32496	96"W x 24"D x 84"H	416.77	217.0
RMP33696	96"W x 36"D x 84"H	515.00	289.0
RMP34896	96"W x 48"D x 84"H	611.79	358.0

3 LEVEL STARTER UNIT - STEEL DECK			
RMS48243	48"W x 24"D x 84"H	293.68	103.0
RMS48363	48"W x 36"D x 84"H	359.91	124.0
RMS48483	48"W x 48"D x 84"H	426.84	151.0
RMS60243	60"W x 24"D x 84"H	350.28	124.0
RMS60363	60"W x 36"D x 84"H	433.21	150.0
RMS60483	60"W x 48"D x 84"H	517.51	184.0
RMS72243	72"W x 24"D x 84"H	419.27	154.0
RMS72363	72"W x 36"D x 84"H	527.68	188.0
RMS72483	72"W x 48"D x 84"H	637.64	232.0
RMS96243	96"W x 24"D x 84"H	507.85	190.0
RMS96363	96"W x 36"D x 84"H	641.46	232.0
RMS96483	96"W x 48"D x 84"H	777.04	286.0

Product #	Size	List Ea.	Shpg. Wt.
-----------	------	----------	-----------

3 LEVEL ADD-ON UNIT - NO DECK			
RMA34824	48"W x 24"D x 84"H	174.65	58.0
RMA34836	48"W x 36"D x 84"H	190.34	64.0
RMA34848	48"W x 48"D x 84"H	204.56	70.0
RMA36024	60"W x 24"D x 84"H	195.00	64.0
RMA36036	60"W x 36"D x 84"H	210.55	70.0
RMA36048	60"W x 48"D x 84"H	224.57	76.0
RMA37224	72"W x 24"D x 84"H	227.74	79.0
RMA37236	72"W x 36"D x 84"H	251.92	88.0
RMA37248	72"W x 48"D x 84"H	274.02	97.0
RMA39624	96"W x 24"D x 84"H	280.07	100.0
RMA39636	96"W x 36"D x 84"H	312.62	112.0
RMA39648	96"W x 48"D x 84"H	342.73	124.0

3 LEVEL ADD-ON UNIT - PARTICLE BOARD DECK			
RAP32448	48"W x 24"D x 84"H	238.76	118.0
RAP33648	48"W x 36"D x 84"H	286.37	151.0
RAP34848	48"W x 48"D x 84"H	332.59	187.0
RAP32460	60"W x 24"D x 84"H	275.08	139.0
RAP33660	60"W x 36"D x 84"H	331.10	181.0
RAP34860	60"W x 48"D x 84"H	385.49	223.00
RAP32472	72"W x 24"D x 84"H	323.65	166.0
RAP33672	72"W x 36"D x 84"H	396.15	220.0
RAP34872	72"W x 48"D x 84"H	466.29	274.0
RAP32496	96"W x 24"D x 84"H	406.52	217.0
RAP33696	96"W x 36"D x 84"H	504.75	289.0
RAP34896	96"W x 48"D x 84"H	601.55	358.0

3 LEVEL ADD-ON UNIT - STEEL DECK			
RAS48243	48"W x 24"D x 84"H	283.40	103.0
RAS48363	48"W x 36"D x 84"H	349.62	124.0
RAS48483	48"W x 48"D x 84"H	416.56	151.0
RAS60243	60"W x 24"D x 84"H	340.00	124.0
RAS60363	60"W x 36"D x 84"H	422.93	159.0
RAS60483	60"W x 48"D x 84"H	507.23	184.0
RAS72243	72"W x 24"D x 84"H	408.99	154.0
RAS72363	72"W x 36"D x 84"H	517.38	188.0
RAS72483	72"W x 48"D x 84"H	627.37	232.0
RAS96243	96"W x 24"D x 84"H	497.56	190.0
RAS96363	96"W x 36"D x 84"H	631.17	232.0
RAS96483	96"W x 48"D x 84"H	766.74	286.0

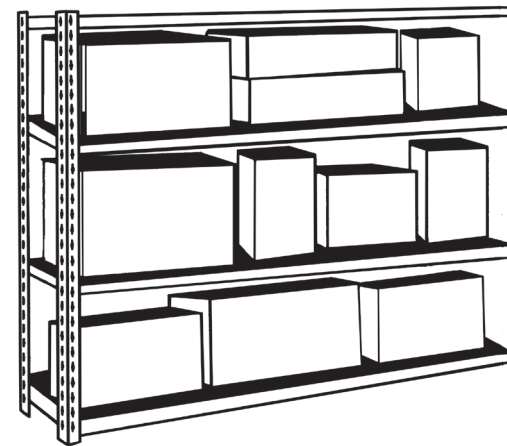
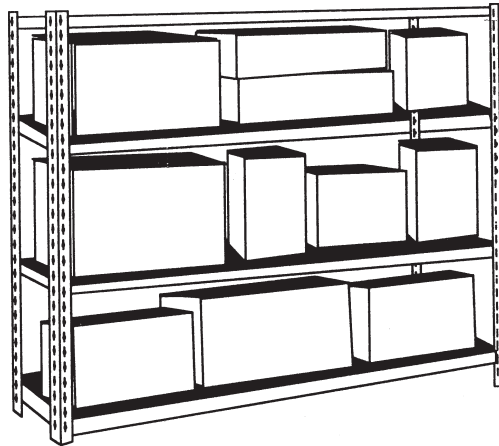

Product #	Size	List Ea.	Shpg. Wt.
-----------	------	----------	-----------

4 LEVEL STARTER UNIT - NO DECK

RMU44824	48"W x 24"D x 84"H	219.47	72.0
RMU44836	48"W x 36"D x 84"H	240.09	80.0
RMU44848	48"W x 48"D x 84"H	258.74	88.0
RMU46024	60"W x 24"D x 84"H	246.66	80.0
RMU46036	60"W x 36"D x 84"H	267.12	88.0
RMU46048	60"W x 48"D x 84"H	285.56	96.0
RMU47224	72"W x 24"D x 84"H	289.66	100.0
RMU47236	72"W x 36"D x 84"H	321.60	112.0
RMU47248	72"W x 48"D x 84"H	350.78	124.0
RMU49624	96"W x 24"D x 84"H	358.80	128.0
RMU49636	96"W x 36"D x 84"H	401.97	144.0
RMU49648	96"W x 48"D x 84"H	441.81	160.0

4 LEVEL STARTER UNIT - PARTICLE BOARD DECK

RMP42448	48"W x 24"D x 84"H	305.01	152.0
RMP43648	48"W x 36"D x 84"H	368.21	196.0
RMP44848	48"W x 48"D x 84"H	429.54	244.0
RMP42460	60"W x 24"D x 84"H	353.50	180.0
RMP43660	60"W x 36"D x 84"H	427.89	236.0
RMP44860	60"W x 48"D x 84"H	500.15	292.0
RMP42472	72"W x 24"D x 84"H	417.51	216.0
RMP43672	72"W x 36"D x 84"H	513.94	288.0
RMP44872	72"W x 48"D x 84"H	607.20	360.0
RMP42496	96"W x 24"D x 84"H	527.45	284.0
RMP43696	96"W x 36"D x 84"H	658.20	380.0
RMP44896	96"W x 48"D x 84"H	786.95	472.0

4 LEVEL STARTER UNIT - STEEL DECK

RMS48244	48"W x 24"D x 84"H	364.47	132.0
RMS48364	48"W x 36"D x 84"H	452.47	160.0
RMS48484	48"W x 48"D x 84"H	541.42	196.0
RMS60244	60"W x 24"D x 84"H	427.92	155.0
RMS60364	60"W x 36"D x 84"H	532.59	188.0
RMS60484	60"W x 48"D x 84"H	638.91	231.0
RMS72244	72"W x 24"D x 84"H	507.15	190.0
RMS72364	72"W x 36"D x 84"H	640.15	232.0
RMS72484	72"W x 48"D x 84"H	774.80	286.0
RMS96244	96"W x 24"D x 84"H	648.80	248.0
RMS96364	96"W x 36"D x 84"H	826.71	304.0
RMS96484	96"W x 48"D x 84"H	1,007.15	376.0

Product #	Size	List Ea.	Shpg. Wt.
-----------	------	----------	-----------

4 LEVEL ADD-ON UNIT - NO DECK

RMA44824	48"W x 24"D x 84"H	209.20	72.0
RMA44836	48"W x 36"D x 84"H	229.82	80.0
RMA44848	48"W x 48"D x 84"H	248.46	88.0
RMA46024	60"W x 24"D x 84"H	236.36	80.0
RMA46036	60"W x 36"D x 84"H	256.81	88.0
RMA46048	60"W x 48"D x 84"H	275.29	96.0
RMA47224	72"W x 24"D x 84"H	279.35	100.0
RMA47236	72"W x 36"D x 84"H	311.29	112.0
RMA47248	72"W x 48"D x 84"H	340.48	124.0
RMA49624	96"W x 24"D x 84"H	348.50	128.0
RMA49636	96"W x 36"D x 84"H	391.67	144.0
RMA49648	96"W x 48"D x 84"H	431.50	160.0

4 LEVEL ADD-ON UNIT - PARTICLE BOARD DECK

RAP42448	48"W x 24"D x 84"H	294.75	152.0
RAP43648	48"W x 36"D x 84"H	357.97	196.0
RAP44848	48"W x 48"D x 84"H	419.27	244.0
RAP42460	60"W x 24"D x 84"H	343.27	180.0
RAP43660	60"W x 36"D x 84"H	417.62	236.0
RAP44860	60"W x 48"D x 84"H	489.91	292.0
RAP42472	72"W x 24"D x 84"H	407.33	216.0
RAP43672	72"W x 36"D x 84"H	503.69	288.0
RAP44872	72"W x 48"D x 84"H	596.96	360.0
RAP42496	96"W x 24"D x 84"H	517.19	284.0
RAP43696	96"W x 36"D x 84"H	647.94	380.0
RAP44896	96"W x 48"D x 84"H	776.69	472.0

4 LEVEL ADD-ON UNIT - STEEL DECK

RAS48244	48"W x 24"D x 84"H	354.17	132.0
RAS48364	48"W x 36"D x 84"H	442.20	160.0
RAS48484	48"W x 48"D x 84"H	531.12	196.0
RAS60244	60"W x 24"D x 84"H	417.61	155.0
RAS60364	60"W x 36"D x 84"H	522.29	188.0
RAS60484	60"W x 48"D x 84"H	628.63	231.0
RAS72244	72"W x 24"D x 84"H	496.87	190.0
RAS72364	72"W x 36"D x 84"H	629.86	232.0
RAS72484	72"W x 48"D x 84"H	764.49	286.0
RAS96244	96"W x 24"D x 84"H	638.53	248.0
RAS96364	96"W x 36"D x 84"H	816.43	304.0
RAS96484	96"W x 48"D x 84"H	996.87	376.0

**CLASS
A**

RIVET LOCK BOLTLESS SHELVING



CATALOG PAGE 50

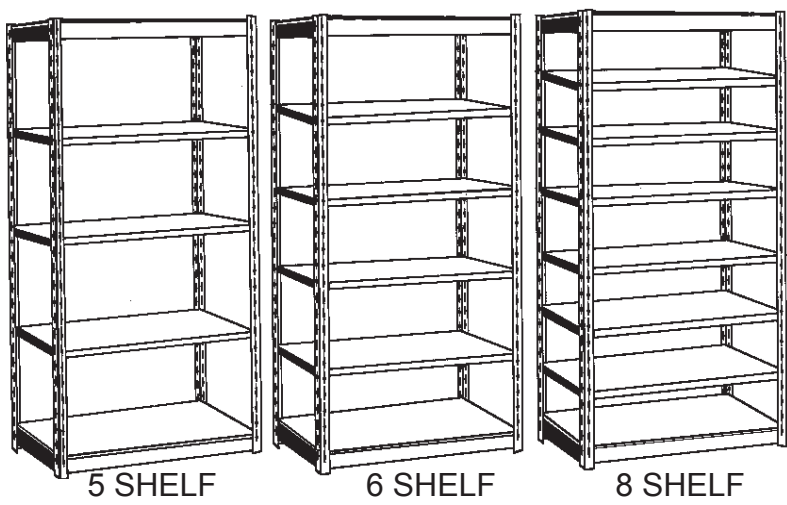

*WOOD DECK NOT INCLUDED. See Below For Particleboard Wood Deck Pricing.

Product Number	Width	Depth	List Price Each	Shpg. Wt. (Lbs.)
5 SHELF RIVET LOCK SHELVING				
RS1500	36"	12"	117.22	38
RS1501	36"	18"	121.22	39
RS1502	36"	24"	125.47	42
RS1503	48"	12"	131.93	43
RS1504	48"	18"	134.71	45
RS1505	48"	24"	140.04	47
6 SHELF RIVET LOCK SHELVING				
RS1506	36"	12"	126.03	41
RS1507	36"	18"	130.02	42
RS1508	36"	24"	134.27	44
RS1509	48"	12"	142.32	47
RS1510	48"	18"	145.11	49
RS1511	48"	24"	150.43	51
8 SHELF RIVET LOCK SHELVING				
RS1512	36"	12"	143.66	47
RS1513	36"	18"	147.65	48
RS1514	36"	24"	151.86	49
RS1515	48"	12"	163.11	55
RS1516	48"	18"	165.91	57
RS1517	48"	24"	171.22	59

**CLASS
A**

PARTICLEBOARD SHELF DECKING



CATALOG PAGE 50



Product Number	Size W" x D"	List Price	Shpg. Wt. (Lbs.)
RLPB 1236	36 x 12	6.93	8
RLPB 1836	36 x 18	10.30	12
RLPB 2436	36 x 24	13.64	16
RLPB 1248	48 x 12	9.05	10
RLPB 1848	48 x 18	13.58	16
RLPB 2448	48 x 24	21.41	20

**CLASS
A**

BOLTLESS GRAVITY FLOW SHELVING



CATALOG PAGE 51

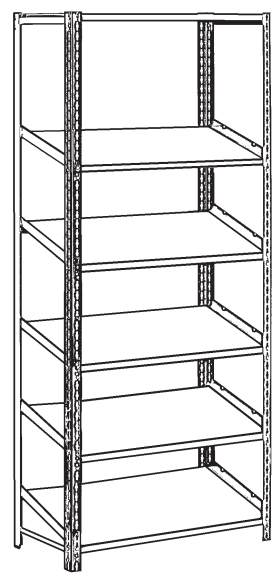

Product Number	Description	Size W" x D" x H"	List Each	Weight Each
GFRS3618	5 Shelf Starter	36 x 18 x 84	284.76	137.0
GFRS3624	5 Shelf Starter	36 x 24 x 84	326.31	161.0
GFRS4818	5 Shelf Starter	48 x 18 x 84	339.10	166.0
GFRS4824	5 Shelf Starter	48 x 24 x 84	391.07	197.0
GFRA3618	5 Shelf Add-On	36 x 18 x 84	281.01	127.0
GFRA3624	5 Shelf Add-On	36 x 24 x 84	322.50	151.0
GFRA4818	5 Shelf Add-On	48 x 18 x 84	335.31	155.0
GFRA4824	5 Shelf Add-On	48 x 24 x 84	387.28	187.0

**CLASS
A**

RIVET LOCK RECORD STORAGE SYSTEMS



CATALOG PAGE 52



Product Number	Size W" x D" x H"	Levels	No. of Boxes	List Price Each	Shpg. Wt. (Lbs.)
----------------	-------------------	--------	--------------	-----------------	------------------

COMPLETE RECORD STORAGE SYSTEM WITH BOXES

RLRS2309	42 x 16 ¹⁵ / ₁₆ x 60	3	18	260.81	105
RLRS2310	42 x 32 ⁷ / ₈ x 60	3	36	417.97	175
RLRS2311	42 x 16 ¹⁵ / ₁₆ x 84	4	24	351.27	142
RLRS2312	42 x 32 ⁷ / ₈ x 84	4	48	560.84	230
RLRS2409	69 x 16 ¹⁵ / ₁₆ x 60	3	30	380.83	147
RLRS2410	69 x 32 ⁷ / ₈ x 60	3	60	619.86	249
RLRS2411	69 x 16 ¹⁵ / ₁₆ x 84	4	40	508.53	200
RLRS2412	69 x 32 ⁷ / ₈ x 84	4	80	830.01	334

RACK AND DECK ONLY (No Boxes)

RLRS2313	42 x 16 ¹⁵ / ₁₆ x 60	3	-	161.43	83
RLRS2314	42 x 32 ⁷ / ₈ x 60	3	-	219.24	131
RLRS2315	42 x 16 ¹⁵ / ₁₆ x 84	4	-	218.75	112
RLRS2316	42 x 32 ⁷ / ₈ x 84	4	-	295.82	176
RLRS2413	69 x 16 ¹⁵ / ₁₆ x 60	3	-	213.99	111
RLRS2414	69 x 32 ⁷ / ₈ x 60	3	-	290.34	174
RLRS2415	69 x 16 ¹⁵ / ₁₆ x 84	4	-	288.85	150
RLRS2416	69 x 32 ⁷ / ₈ x 84	4	-	390.64	234

PARTICLEBOARD



Product Number	Size W x D	List Price Each	Shpg. Wt. (Lbs.)
RLPB1542	42 x 16 ¹⁵ / ₁₆	13.67	12
RLPB3042	42 x 32 ⁷ / ₈	27.53	24
RLPB1569	69 x 16 ¹⁵ / ₁₆	20.28	18
RLPB3069	69 x 32 ⁷ / ₈	40.29	36



RECORDS STORAGE BOXES

Product Number	Qty. Per Cs.	Size W" x D" x H"	List Price Each Cs.	Shpg. Wt. (Lbs.)
RSC12	12	12 x 15 x 10	66.26	15
RSC15	15	12 x 15 x 10	83.42	18
RSC18	18	12 x 15 x 10	99.37	22
RSC20	20	12 x 15 x 10	109.83	25

**CLASS
A**

RIVET LOCK RECORD STORAGE RACK/RAIL SYSTEM

CATALOG PAGE 52



Product #	Size W" x D" x H"	Levels	Strge Box Cap.	Color	List Each	Wt.
RR31318	42"x16 ¹⁵ / ₁₆ "x60"	3	18	Tan	111.79	50.0
RR32336	42"x32 ⁷ / ₈ "x60"	3	36	Tan	147.94	70.0
RR41324	42"x16 ¹⁵ / ₁₆ "x84"	4	24	Tan	149.87	70.0
RR42348	42"x32 ⁷ / ₈ "x84"	4	48	Tan	198.41	96.0

Records storage boxes not included.

**CLASS
A**

TIRE RACK

CATALOG PAGE 53



**CLASS
A**

BOLTLESS MOBILE SHELF TRUCK

CATALOG PAGE 53

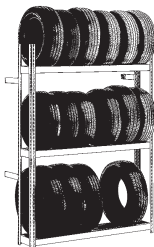

Product Number	Description	W" x D" x H"	List Each	Weight Each
TRB6012	Single Entry, 24 Tire	60 x 12 x 84	134.64	70.0
TRB6042	Double Entry, 42 Tire	60 x 42 x 84	271.37	135.0



Product Number	Description	W" x D" x H"	List Each	Weight Each
RT362454-3	3 Shelf	36 x 24 x 54	172.68	114.0
RT482454-3	3 Shelf	48 x 24 x 54	193.12	132.0
RT602454-3	3 Shelf	60 x 24 x 54	213.28	168.0
RT362466-4	4 Shelf	36 x 24 x 66	195.71	142.0
RT482466-4	4 Shelf	48 x 24 x 66	219.40	167.0
RT602466-4	4 Shelf	60 x 24 x 66	242.89	202.0

CLASS A RIVET LOCK POSTS



CATALOG PAGE 54



Product #	Size	List Ea.	Wt.
HEAVY DUTY POSTS			
RLU60	60"	11.44	5
RLU72	72"	13.80	6
RLU84	84"	16.12	7
RLU96	96"	18.38	7
RLU120	120"	22.96	9

HEAVY DUTY



Product #	Size	List Ea.	Wt.
STANDARD POSTS			
RLSU 5	60"	9.61	3
RLSU 6	72"	11.44	3
RLSU 7	84"	13.28	4
RLSU 8	96"	15.29	5
RLSU 10	120"	19.51	6

STANDARD



Product #	Size	List Ea.	Wt.
"T" POSTS			
RLPT 5	60"	15.89	6
RLPT 6	72"	18.60	7
RLPT 7	84"	21.40	8
RLPT 8	96"	24.19	9
RLPT 10	120"	30.06	11

"T"

Standard color is gray. For TAN posts add "TN" suffix to product #.

CLASS A RIVET LOCK BEAMS



CATALOG PAGE 54

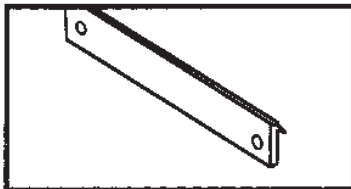

SINGLE RIVET ANGLE BEAM

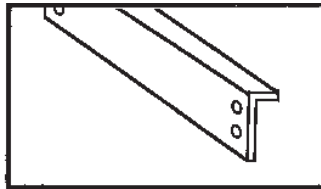

DOUBLE RIVET ANGLE BEAM

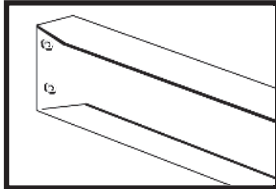

DOUBLE RIVET CHANNEL BEAM

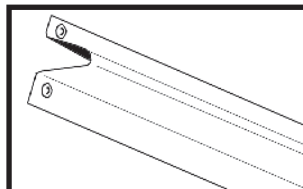

MID-PROFILE BEAM

Product #	Size	List Ea.	Wt.
SINGLE RIVET ANGLE BEAM			
RS-3	36"	4.39	1
RS-4	48"	5.20	2
DOUBLE RIVET ANGLE BEAM			
RLB36	36"	8.41	3
RLB42	42"	8.88	4
RLB48	48"	10.43	4
RLB60	60"	12.46	6
RLB69	69"	14.33	6
RLB72	72"	14.92	6
RLB96	96"	19.28	8
DOUBLE RIVET CHANNEL BEAM			
RLB72HD	72"	18.16	8
RLB96HD	96"	24.19	10
MID-PROFILE BEAM			
RMB48	48" (TAN Only)	11.49	4.0
RMB60	60" (TAN Only)	13.76	5.0
RMB72	72" (TAN Only)	16.46	6.0
RMB96	96" (TAN Only)	21.26	8.0

Standard color is gray. For TAN beams add "TN" suffix to product #.

CLASS A RIVET LOCK FRONT TO BACK TIES AND SUPPORTS



CATALOG PAGE 54

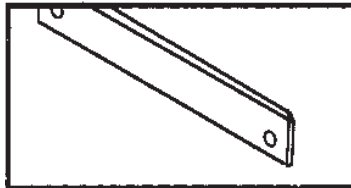

SINGLE RIVET FRONT TO BACK TIES



DOUBLE RIVET FRONT TO BACK TIES

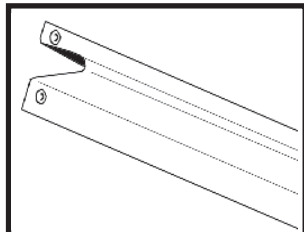

MID-PROFILE FRONT TO BACK SUPPORT

Product #	Size	List Ea.	Wt.
SINGLE RIVET FRONT TO BACK TIES			
RS12	12"	2.08	1
RS18	18"	2.92	1
RS24	24"	3.32	1
DOUBLE RIVET FRONT TO BACK TIES			
RFB 12	12"	3.48	1
RFB 15	15 ^{21/32} "	3.57	1
RFB 18	18"	5.09	2
RFB 24	24"	5.26	2
RFB 30	32 ^{5/32} "	6.29	3
RFB 36	36"	7.52	3
RFB 48	48"	9.54	4
MID-PROFILE FRONT TO BACK SUPPORTS			
RMF24	24"D (TAN only)	5.81	3.0
RMF36	36"D (TAN only)	8.29	4.0
RMF48	48"D (TAN only)	10.50	5.0

Standard color is gray. For TAN ties add "TN" suffix to product #.

**CLASS
A**

RIVET LOCK CENTER SUPPORTS



CATALOG PAGE 55

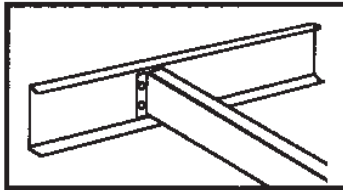

CENTER SUPPORT

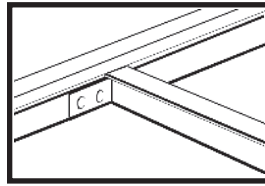

MID-PROFILE CENTER SUPPORT

Product #	Size	List Ea.	Wt.
CENTER SUPPORTS			
CS 15	15 ^{21/32} "	4.75	2
CS 18	18"	5.27	2
CS 24	24"	6.57	2
CS 30	32 ^{5/32} "	7.84	3
CS 36	36"	9.13	3
CS 48	48"	11.54	4
MID-PROFILE CENTER SUPPORTS			
RMC24	24"D (TAN only)	7.26	3.0
RMC36	36"D (TAN only)	10.07	4.0
RMC48	48"D (TAN only)	12.72	5.0

Standard color is gray. For TAN supports add "TN" suffix to product #.

**CLASS
A**

RIVET LOCK DECKING/DECK PANELS



CATALOG PAGE 55



PARTICLE BOARD SHELF DECKING			
Product Number	Size (W" x D")	List Each	Weight
RLPB 1236	36 x 12	6.93	8
RLPB 1836	36 x 18	10.30	12
RLPB 2436	36 x 24	13.64	16
RLPB 1242	42 x 12	8.96	9
RLPB 1842	42 x 18	13.38	14
RLPB 2442	42 x 24	19.51	18
RLPB 1248	48 x 12	9.05	10
RLPB 1848	48 x 18	13.58	16
RLPB 2448	48 x 24	21.41	20
RLPB 3648	48 x 36	32.00	29
RLPB 4848	48 x 48	42.60	39
RLPB 2460	60 x 24	26.72	25
RLPB 3660	60 x 36	40.12	37
RLPB 4860	60 x 48	53.51	49
RLPB 2472	72 x 24	32.00	29
RLPB 3672	72 x 36	48.02	44
RLPB 4872	72 x 48	63.93	59
RLPB 2496	96 x 24	42.16	39
RLPB 3696	96 x 36	63.93	59
RLPB 4896	96 x 48	86.03	78

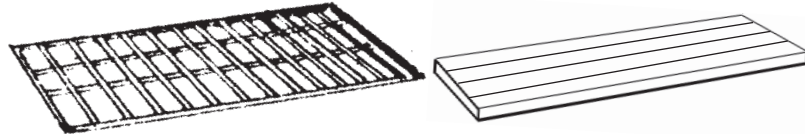

GALVANIZED WIRE SHELF DECKING			
Product Number	Size (W" x D")	List Each	Weight
RWD 2448	48 x 24	83.57	13
RWD 3648	48 x 36	111.22	19
RWD 4848	48 x 48	142.19	27
RWD 2460	60 x 24	100.77	16
RWD 3660	60 x 36	136.45	23
RWD 4860	60 x 48	173.53	34
RWD 2472	72 x 24	117.94	20
RWD 3672	72 x 36	161.72	25
RWD 4872	72 x 48	204.87	39
RWD 2496	96 x 24	167.14	26
RWD 3696	96 x 36	222.41	38
RWD 4896	96 x 48	284.38	54
MID-PROFILE STEEL DECK PANELS*			
Product Number	Size (W" x D")	List Ea.	Wt.
RMD24	12" x 24" (TAN only)	9.07	15
RMD36	12" x 36" (TAN only)	13.28	20
RMD48	12" x 48" (TAN only)	17.66	27

*(Available in 4 packs only.)

**CLASS
A**

HIGH-CAPACITY BOLTLESS SHELVING



CATALOG PAGE 56

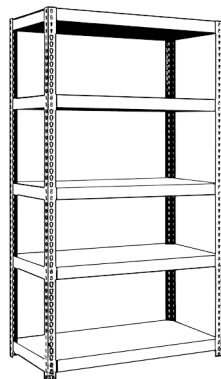

Product Number	Description	W" x D" x H"	List Each	Weight Each
HCU-361884	5 Shelf Unit, 4000 lb/shelf	36 x 18 x 84	288.27	154.0
HCU-481884	5 Shelf Unit, 4000 lb/shelf	48 x 18 x 84	333.47	188.0
HCU-482484	5 Shelf Unit, 4000 lb/shelf	48 x 24 x 84	374.59	220.0
HCU-602484	5 Shelf Unit, 3250 lb/shelf	60 x 24 x 84	428.99	261.0
HCU-722484	5 Shelf Unit, 2750 lb/shelf	72 x 24 x 84	530.99	312.0
HCU-723684	5 Shelf Unit, 2750 lb/shelf	72 x 36 x 84	653.24	453.0
HCU-962484	5 Shelf Unit, 2600 lb/shelf	96 x 24 x 84	656.58	406.0
HCU-963684	5 Shelf Unit, 2600 lb/shelf	96 x 36 x 84	833.78	595.0
HCU-361896	5 Shelf Unit, 4000 lb/shelf	36 x 18 x 96	293.83	157.0
HCU-481896	5 Shelf Unit, 4000 lb/shelf	48 x 18 x 96	339.03	191.0
HCU-482496	5 Shelf Unit, 4000 lb/shelf	48 x 24 x 96	380.15	224.0
HCU-602496	5 Shelf Unit, 3250 lb/shelf	60 x 24 x 96	434.56	265.0
HCU-722496	5 Shelf Unit, 2750 lb/shelf	72 x 24 x 96	536.57	315.0
HCU-723696	5 Shelf Unit, 2750 lb/shelf	72 x 36 x 96	658.81	457.0
HCU-962496	5 Shelf Unit, 2600 lb/shelf	96 x 24 x 96	662.15	457.0
HCU-963696	5 Shelf Unit, 2600 lb/shelf	96 x 36 x 96	839.34	544.0

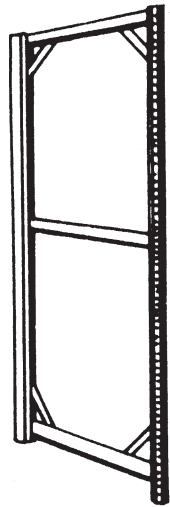

Rack End

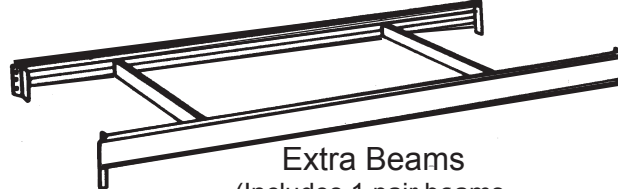

Extra Beams
(Includes 1 pair beams,
2 front-to-back deck supports)

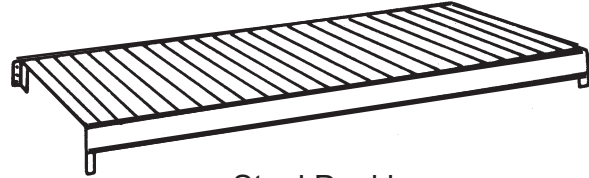

Steel Decking
(Decking does not include beams)

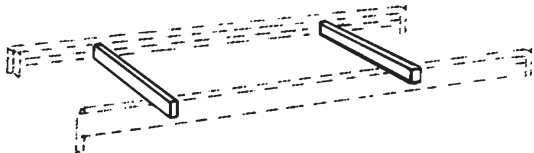

Front-to-Back Deck Supports Only

RACK ENDS

Product Number	Depth	Height	List Price Each Item	Shipping Weight
8624 RE	2'	6'	80.17	30
8636 RE	3'	6'	88.14	32
8648 RE	4'	6'	96.20	35
8824 RE	2'	8'	96.08	36
8836 RE	3'	8'	105.74	38
8848 RE	4'	8'	113.86	40
81024 RE	2'	10'	117.98	41
81036 RE	3'	10'	128.79	43
81048 RE	4'	10'	139.04	46

EXTRA BEAMS

Product Number	Width	Depth	List Price Per Pair	Shipping Weight
9524 BM	5'	2'	61.90	19
9536 BM	5'	3'	66.75	21
9548 BM	5'	4'	71.17	23
9624 BM	6'	2'	69.47	21
9636 BM	6'	3'	74.92	23
9648 BM	6'	4'	80.79	25
9824 BM	8'	2'	87.97	28
9836 BM	8'	3'	93.81	30
9848 BM	8'	4'	99.55	32

STEEL DECKING

Product Number	Width	Depth	List Price Each Item	Shipping Weight
10-2-5 D	5'	2'	47.98	23
10-3-5 D	5'	3'	71.19	35
10-4-5 D	5'	4'	93.34	46
10-2-6 D	6'	2'	56.41	28
10-3-6 D	6'	3'	83.75	42
10-4-6 D	6'	4'	109.87	55
10-2-8 D	8'	2'	74.44	37
10-3-8 D	8'	3'	109.32	55
10-4-8 D	8'	4'	143.27	72

DECK SUPPORTS ONLY

Product Number	Depth	List Price Each Item	Shipping Weight
1124 PS	2'	5.71	1.5
1136 PS	3'	7.60	2.3
1148 PS	4'	9.98	3.0

NOTE:
2 Front-To-Back Deck Supports
are required per level.

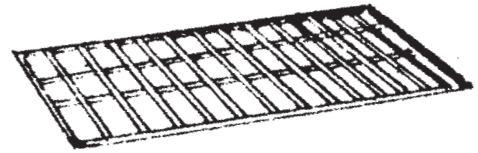

PARTICLE BOARD SHELF DECKING

Product #	Size (W" x D")	List Ea.	Wt.
RLPB 2460	60 x 24	26.72	25
RLPB 3660	60 x 36	40.12	37
RLPB 4860	60 x 48	53.51	49
RLPB 2472	72 x 24	32.00	29
RLPB 3672	72 x 36	48.02	44
RLPB 4872	72 x 48	63.93	59
RLPB 2496	96 x 24	42.16	39
RLPB 3696	96 x 36	63.93	59
RLPB 4896	96 x 48	86.03	78

GALVANIZED WIRE SHELF DECKING

Product #	Size (W" x D")	List Ea.	Wt.
RWD 2460	60 x 24	100.77	16
RWD 3660	60 x 36	136.45	23
RWD 4860	60 x 48	173.53	34
RWD 2472	72 x 24	117.94	20
RWD 3672	72 x 36	161.72	25
RWD 4872	72 x 48	204.87	39
RWD 2496	96 x 24	167.14	26
RWD 3696	96 x 36	222.41	38
RWD 4896	96 x 48	284.38	54

STARTER UNITS

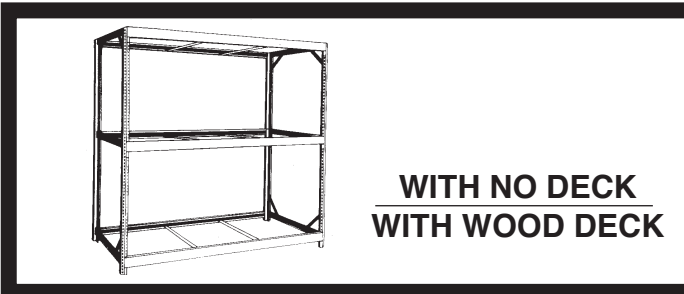

ADD ON UNITS

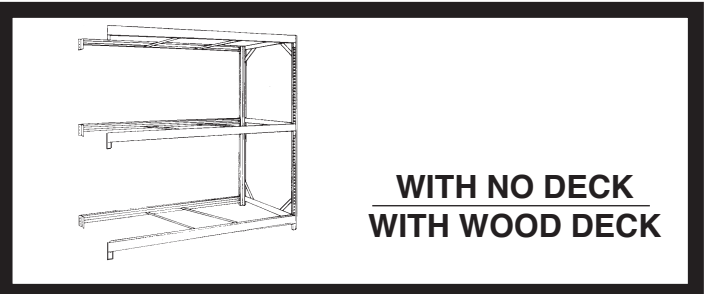

WITH NO DECK

Edsal #	W" x D" x H"	Total List	Total Wt.
4625	60x24x72	\$346.06	117.0
4635	60x36x72	\$376.51	127.0
4645	60x48x72	\$405.87	139.0
4626	72x24x72	\$368.78	123.0
4636	72x36x72	\$401.07	133.0
4646	72x48x72	\$434.75	145.0
4628	96x24x72	\$424.32	144.0
4638	96x36x72	\$457.70	154.0
4648	96x48x72	\$491.08	166.0
4825	60x24x96	\$377.86	129.0
4835	60x36x96	\$411.70	139.0
4845	60x48x96	\$441.19	149.0
4826	72x24x96	\$400.59	135.0
4836	72x36x96	\$436.24	145.0
4846	72x48x96	\$470.07	155.0
4828	96x24x96	\$456.11	156.0
4838	96x36x96	\$492.87	166.0
4848	96x48x96	\$526.40	176.0
41025	60x24x120	\$421.64	139.0
41035	60x36x120	\$457.81	149.0
41045	60x48x120	\$491.55	161.0
41026	72x24x120	\$444.38	145.0
41036	72x36x120	\$482.35	155.0
41046	72x48x120	\$520.41	167.0
41028	96x24x120	\$499.90	166.0
41038	96x36x120	\$538.98	176.0
41048	96x48x120	\$576.73	188.0

WITH NO DECK

Edsal #	W" x D" x H"	Total Lis	Total Wt.
5625	60x24x72	\$265.90	87.0
5635	60x36x72	\$288.37	95.0
5645	60x48x72	\$309.68	104.0
5626	72x24x72	\$288.60	93.0
5636	72x36x72	\$312.92	101.0
5646	72x48x72	\$338.54	110.0
5628	96x24x72	\$344.15	114.0
5638	96x36x72	\$369.56	122.0
5648	96x48x72	\$394.87	131.0
5825	60x24x96	\$281.79	93.0
5835	60x36x96	\$305.97	101.0
5845	60x48x96	\$327.34	109.0
5826	72x24x96	\$304.50	99.0
5836	72x36x96	\$330.51	107.0
5846	72x48x96	\$356.21	115.0
5828	96x24x96	\$360.04	120.0
5838	96x36x96	\$387.15	128.0
5848	96x48x96	\$412.55	136.0
51025	60x24x120	\$303.69	98.0
51035	60x36x120	\$329.01	106.0
51045	60x48x120	\$352.50	115.0
51026	72x24x120	\$326.40	104.0
51036	72x36x120	\$353.57	112.0
51046	72x48x120	\$381.37	121.0
51028	96x24x120	\$381.94	125.0
51038	96x36x120	\$410.20	133.0
51048	96x48x120	\$437.72	142.0

WITH WOOD DECK

Edsal #	W" x D" x H"	Total List	Total Wt.
4625PD	60x24x72	\$372.44	192.0
4635PD	60x36x72	\$432.91	238.0
4645PD	60x48x72	\$492.33	286.0
4626PD	72x24x72	\$405.72	210.0
4636PD	72x36x72	\$474.34	265.0
4646PD	72x48x72	\$543.97	322.0
4628PD	96x24x72	\$480.23	261.0
4638PD	96x36x72	\$564.23	331.0
4648PD	96x48x72	\$649.05	400.0
4825PD	60x24x96	\$400.50	204.0
4835PD	60x36x96	\$463.99	250.0
4845PD	60x48x96	\$523.52	296.0
4826PD	72x24x96	\$433.80	222.0
4836PD	72x36x96	\$505.41	277.0
4846PD	72x48x96	\$575.15	332.0
4828PD	96x24x96	\$508.29	273.0
4838PD	96x36x96	\$684.57	343.0
4848PD	96x48x96	\$680.24	410.0
41025PD	60x24x120	\$439.17	214.0
41035PD	60x36x120	\$504.67	260.0
41045PD	60x48x120	\$567.95	308.0
41026PD	72x24x120	\$472.45	232.0
41036PD	72x36x120	\$546.09	287.0
41046PD	72x48x120	\$619.57	344.0
41028PD	96x24x120	\$546.95	283.0
41038PD	96x36x120	\$635.98	353.0
41048PD	96x48x120	\$724.68	422.0

WITH WOOD DECK

Edsal #	W" x D" x H"	Total List	Total Wt.
5625PD	60x24x72	\$301.68	162.0
5635PD	60x36x72	\$355.11	206.0
5645PD	60x48x72	\$407.43	251.0
5626PD	72x24x72	\$334.96	180.0
5636PD	72x36x72	\$396.54	233.0
5646PD	72x48x72	\$459.07	287.0
5628PD	96x24x72	\$409.46	231.0
5638PD	96x36x72	\$486.43	299.0
5648PD	96x48x72	\$564.15	365.0
5825PD	60x24x96	\$315.71	168.0
5835PD	60x36x96	\$370.64	212.0
5845PD	60x48x96	\$423.02	256.0
5826PD	72x24x96	\$348.99	186.0
5836PD	72x36x96	\$412.07	239.0
5846PD	72x48x96	\$474.66	292.0
5828PD	96x24x96	\$424.24	237.0
5838PD	96x36x96	\$501.95	305.0
5848PD	96x48x96	\$579.74	370.0
51025PD	60x24x120	\$335.05	173.0
51035PD	60x36x120	\$390.98	217.0
51045PD	60x48x120	\$445.23	262.0
51026PD	72x24x120	\$368.33	191.0
51036PD	72x36x120	\$432.42	244.0
51046PD	72x48x120	\$496.85	298.0
51028PD	96x24x120	\$442.83	242.0
51038PD	96x36x120	\$522.31	310.0
51048PD	96x48x120	\$601.96	376.0

ADDITIONAL LEVELS WITH NO DECK

Edsal #	W" x D"	Total List	Total Wt.
9524BM	60x24	\$61.90	19.0
9536BM	60x36	\$66.75	21.0
9548BM	60x48	\$71.17	23.0
9624BM	72x24	\$69.47	21.0
9636BM	72x36	\$74.92	23.0
9648BM	72x48	\$80.79	25.0
9824BM	96x24	\$87.97	28.0
9836BM	96x36	\$93.81	30.0
9848BM	96x48	\$99.55	32.0

ADDITIONAL LEVELS WITH WOOD DECK

Edsal #	W" x D"	Total List	Total Wt.
9524BMPD	60x24	\$76.97	44.0
9536BMPD	60x36	\$92.42	58.0
9548BMPD	60x48	\$107.50	72.0
9624BMPD	72x24	\$88.06	50.0
9636BMPD	72x36	\$122.18	67.0
9648BMPD	72x48	\$124.71	84.0
9824BMPD	96x24	\$112.89	67.0
9836BMPD	96x36	\$156.63	89.0
9848BMPD	96x48	\$159.74	110.0



STARTER UNITS



**WITH STEEL DECK
WITH WIRE DECK**

ADD-ON UNITS



**WITH STEEL DECK
WITH WIRE DECK**

WITH STEEL DECK

Edsal #	W" x D" x H"	Total List	Total Wt.
6625	60x24x72	\$490.01	186.0
6635	60x36x72	\$590.08	232.0
6645	60x48x72	\$685.87	277.0
6626	72x24x72	\$537.99	207.0
6636	72x36x72	\$652.29	259.0
6646	72x48x72	\$764.35	310.0
6628	96x24x72	\$647.61	255.0
6638	96x36x72	\$785.65	319.0
6648	96x48x72	\$920.91	382.0
6825	60x24x96	\$521.79	198.0
6835	60x36x96	\$625.26	244.0
6845	60x48x96	\$721.22	287.0
6826	72x24x96	\$569.78	219.0
6836	72x36x96	\$687.48	271.0
6846	72x48x96	\$799.67	320.0
6828	96x24x96	\$679.42	267.0
6838	96x36x96	\$820.83	331.0
6848	96x48x96	\$956.23	392.0
61025	60x24x120	\$565.58	208.0
61035	60x36x120	\$671.36	254.0
61045	60x48x120	\$771.54	299.0
61026	72x24x120	\$613.59	229.0
61036	72x36x120	\$733.60	281.0
61046	72x48x120	\$850.01	332.0
61028	96x24x120	\$723.21	277.0
61038	96x36x120	\$866.94	341.0
61048	96x48x120	\$1,006.56	404.0

WITH STEEL DECK

Edsal #	W" x D" x H"	Total List	Total Wt.
7625	60x24x72	\$409.83	156.0
7635	60x36x72	\$501.94	200.0
7645	60x48x72	\$589.68	242.0
7626	72x24x72	\$457.82	177.0
7636	72x36x72	\$564.16	227.0
7646	72x48x72	\$668.16	275.0
7628	96x24x72	\$567.42	225.0
7638	96x36x72	\$697.52	287.0
7648	96x48x72	\$824.71	347.0
7825	60x24x96	\$425.73	162.0
7835	60x36x96	\$519.53	206.0
7845	60x48x96	\$607.34	247.0
7826	72x24x96	\$473.73	183.0
7836	72x36x96	\$581.73	233.0
7846	72x48x96	\$685.82	280.0
7828	96x24x96	\$583.33	231.0
7838	96x36x96	\$715.09	293.0
7848	96x48x96	\$842.38	352.0
71025	60x24x120	\$447.63	167.0
71035	60x36x120	\$542.59	211.0
71045	60x48x120	\$632.52	253.0
71026	72x24x120	\$495.62	188.0
71036	72x36x120	\$604.79	238.0
71046	72x48x120	\$710.99	286.0
71028	96x24x120	\$605.23	236.0
71038	96x36x120	\$738.14	298.0
71048	96x48x120	\$867.54	358.0

WITH WIRE DECK

Edsal #	W" x D" x H"	Total List	Total Wt.
6625WD	60x24x72	\$563.76	165.0
6635WD	60x36x72	\$683.39	196.0
6645WD	60x48x72	\$805.60	241.0
6626WD	72x24x72	\$628.36	183.0
6636WD	72x36x72	\$770.62	208.0
6646WD	72x48x72	\$912.49	262.0
6628WD	96x24x72	\$805.00	222.0
6638WD	96x36x72	\$978.21	268.0
6648WD	96x48x72	\$1,168.89	328.0
6825WD	60x24x96	\$591.42	177.0
6835WD	60x36x96	\$713.99	208.0
6845WD	60x48x96	\$836.33	251.0
6826WD	72x24x96	\$656.01	195.0
6836WD	72x36x96	\$801.22	220.0
6846WD	72x48x96	\$943.20	272.0
6828WD	96x24x96	\$832.67	234.0
6838WD	96x36x96	\$1,008.82	280.0
6848WD	96x48x96	\$1,199.60	338.0
61025WD	60x24x120	\$629.50	187.0
61035WD	60x36x120	\$754.07	218.0
61045WD	60x48x120	\$880.10	263.0
61026WD	72x24x120	\$694.09	205.0
61036WD	72x36x120	\$841.31	230.0
61046WD	72x48x120	\$986.96	284.0
61028WD	96x24x120	\$870.74	244.0
61038WD	96x36x120	\$1,048.90	290.0
61048WD	96x48x120	\$1,243.36	350.0

WITH WIRE DECK

Edsal #	W" x D"	Total List	Total Wt.
7625WD	60x24x72	\$494.05	135.0
7635WD	60x36x72	\$606.76	164.0
7645WD	60x48x72	\$721.95	206.0
7626WD	72x24x72	\$558.64	153.0
7636WD	72x36x72	\$693.97	176.0
7646WD	72x48x72	\$828.84	227.0
7628WD	96x24x72	\$735.28	192.0
7638WD	96x36x72	\$901.58	236.0
7648WD	96x48x72	\$1,085.24	293.0
7825WD	60x24x96	\$507.87	141.0
7835WD	60x36x96	\$622.04	170.0
7845WD	60x48x96	\$737.31	211.0
7826WD	72x24x96	\$572.47	159.0
7836WD	72x36x96	\$709.27	182.0
7846WD	72x48x96	\$844.19	232.0
7828WD	96x24x96	\$749.11	198.0
7838WD	96x36x96	\$916.87	242.0
7848WD	96x48x96	\$1,100.59	298.0
71025WD	60x24x120	\$526.92	146.0
71035WD	60x36x120	\$642.09	175.0
71045WD	60x48x120	\$759.20	217.0
71026WD	72x24x120	\$591.50	164.0
71036WD	72x36x120	\$729.32	187.0
71046WD	72x48x120	\$866.07	238.0
71028WD	96x24x120	\$768.15	203.0
71038WD	96x36x120	\$936.92	247.0
71048WD	96x48x120	\$1,122.48	304.0

ADDITIONAL LEVELS WITH STEEL DECK

Edsal #	W" x D"	Total List	Total Wt.
9524BMS	60x24	\$95.54	42.0
9536BMS	60x36	\$119.95	56.0
9548BMS	60x48	\$143.04	69.0
9624BMS	72x24	\$109.46	49.0
9636BMS	72x36	\$137.98	65.0
9648BMS	72x48	\$165.79	80.0
9824BMS	96x24	\$141.23	65.0
9836BMS	96x36	\$176.62	85.0
9848BMS	96x48	\$211.16	104.0

ADDITIONAL LEVELS WITH WIRE DECK

Edsal #	W" x D" x H"	Total List	Total Wt.
9524BMWD	60x24	\$141.45	35.0
9536BMWD	60x36	\$176.71	44.0
9548BMWD	60x48	\$212.76	57.0
9624BMWD	72x24	\$162.97	41.0
9636BMWD	72x36	\$205.76	48.0
9648BMWD	72x48	\$248.40	64.0
9824BMWD	96x24	\$221.86	54.0
9836BMWD	96x36	\$274.98	68.0
9848BMWD	96x48	\$333.86	86.0

**CLASS
A**

SYSTEM II - ACCESSORIES



CATALOG PAGE 60-61

Product Number	List Price Each Item	Approx. Shipping Wt.
Mezzanine Bracket		
2MB-1000	8.53	1.0
Anchoring Foot Plate		
2AF-1000	3.50	.5
Coupler Splicer		
2PC-1100	2.53	.2
Separator Bar - Not Illustrated (p.61)		
2SEP-15	13.18	1.5

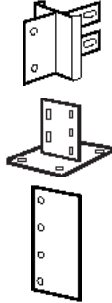

Product Number	Size	List Price Each Item	Approx. Shipping Wt.
Wall Ties			
2WT-9	9"	12.39	1.2
2WT-12	12"	14.77	1.5
Double Entry Row Spacer			
2DES-9	9"	16.02	1.7
2DES-12	12"	18.42	2.0
Aisle Ties			
2AT-36	36"	30.62	4.0
2AT-42	42"	34.35	4.5

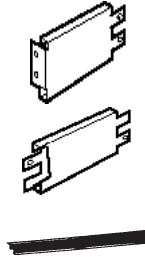

**CLASS
A**

SYSTEM II - AUTOMOTIVE RACKS



CATALOG PAGE 61

TIRE RACKS

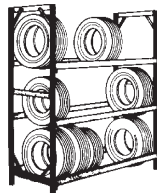

3 Tier

THREE TIER

	Product Number	List Price Each Item	Approx. Shpg. Wt.
Single Entry Starter	TR-8851	359.25	127
	TR-8881	442.53	154
Single Entry Add-On	TR-9851	256.56	91
	TR-9881	340.14	118
Double Entry Starter	TR-8852	782.71	261
	TR-8882	949.57	315
Double Entry Add-On	TR-9852	545.42	189
	TR-9882	712.09	243



4 Tier

FOUR TIER

	Product Number	List Price Each Item	Approx. Shpg. Wt.
Single Entry Starter	TR-81051	467.84	154
	TR-81081	579.23	190
Single Entry Add-On	TR-91051	342.08	113
	TR-91081	453.26	149
Double Entry Starter	TR-81052	1,032.30	318
	TR-81082	1,254.91	390
Double Entry Add-On	TR-91052	732.60	231
	TR-91082	954.57	305

TAIL PIPE RACKS

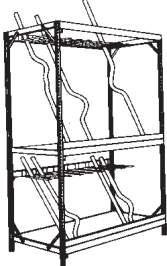

Starter

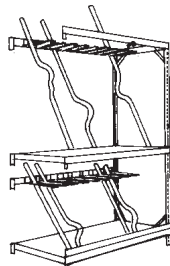

Add-On

	Product Number	List Price Each Item	Separator Bars Incl.	Approx. Shpg. Wt.
Starters	TP-8850	523.22	9	142
	TP-8880	684.87	15	177
	TP-81050	753.85	18	181
	TP-81080	1,023.56	30	190
Add-Ons	TP-9850	419.84	9	106
	TP-9880	582.40	15	141
	TP-91050	651.20	18	143
	TP-91080	897.58	30	150

*Note: Particleboard NOT included.

V-BELT RACKS

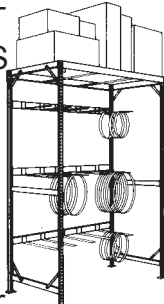

Starter

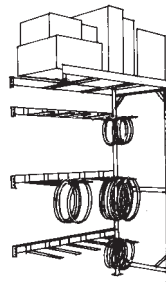

Add-On

	Product Number	List Price Each Item	Separator Bars Incl.	Approx. Shpg. Wt.
Starters	VBR-8850	568.30	15	140
	VBR-8880	796.17	27	180
Add-Ons	VBR-9850	465.63	15	104
	VBR-9880	693.54	27	144

*Note: Particleboard NOT included.

E-Rack Welded Components

Edsal #	Description	Size	List Ea.	Wt. Ea.
ERF2472	Welded Frame	24"D x 72" H	\$79.18	23.0
ERF2496	Welded Frame	24"D x 96" H	\$103.20	32.0
ERF24120	Welded Frame	24"D x 120" H	\$117.94	38.0
ERF3672	Welded Frame	36"D x 72" H	\$86.33	25.0
ERF3696	Welded Frame	36"D x 96" H	\$111.94	36.0
ERF36120	Welded Frame	36"D x 120" H	\$128.32	42.0
ERF4872	Welded Frame	48"D x 72" H	\$90.57	27.0
ERF4896	Welded Frame	48"D x 96" H	\$118.23	39.0
ERF48120	Welded Frame	48"D x 120" H	\$133.20	45.0
ERB60	Beam (use 1 tie bar)	60" Wide	\$27.32	10.0
ERB72	Beam (use 2 tie bars)	72" Wide	\$31.03	12.0
ERB96	Beam (use 2 tie bars)	96" Wide	\$36.68	15.0
ERTB24	Tie Bar	24" Deep	\$3.19	2.0
ERTB36	Tie Bar	36" Deep	\$3.74	2.0
ERTB48	Tie Bar	48" Deep	\$4.24	3.0
ERD6024	Steel Deck	60"W x 24"D	\$41.53	23.0
ERD6036	Steel Deck	60"W x 36"D	\$61.65	35.0
ERD6048	Steel Deck	60"W x 48"D	\$80.80	46.0
ERD7224	Steel Deck	72"W x 24"D	\$48.82	28.0
ERD7236	Steel Deck	72"W x 36"D	\$72.51	42.0
ERD7248	Steel Deck	72"W x 48"D	\$95.10	55.0
ERD9624	Steel Deck	96"W x 24"D	\$64.42	37.0
ERD9636	Steel Deck	96"W x 36"D	\$94.61	55.0
ERD9648	Steel Deck	96"W x 48"D	\$124.02	72.0

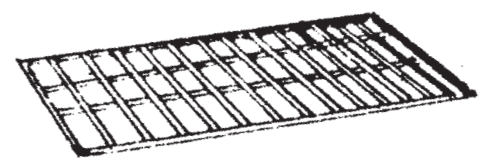

PARTICLE BOARD SHELF DECKING

Product #	Size (W" x D")	List Ea.	Wt.
RLPB 2460	60 x 24	26.72	25
RLPB 3660	60 x 36	40.12	37
RLPB 4860	60 x 48	53.51	49
RLPB 2472	72 x 24	32.00	29
RLPB 3672	72 x 36	48.02	44
RLPB 4872	72 x 48	63.93	59
RLPB 2496	96 x 24	42.16	39
RLPB 3696	96 x 36	63.93	59
RLPB 4896	96 x 48	86.03	78

GALVANIZED WIRE SHELF DECKING

Product #	Size (W" x D")	List Ea.	Wt.
RWD 2460	60 x 24	100.77	16
RWD 3660	60 x 36	136.45	23
RWD 4860	60 x 48	173.53	34
RWD 2472	72 x 24	117.94	20
RWD 3672	72 x 36	161.72	25
RWD 4872	72 x 48	204.87	39
RWD 2496	96 x 24	167.14	26
RWD 3696	96 x 36	222.41	38
RWD 4896	96 x 48	284.38	54

**CLASS
A**

WELDED FRAME BULK E-RACK



CATALOG PAGE 63

STARTER UNITS

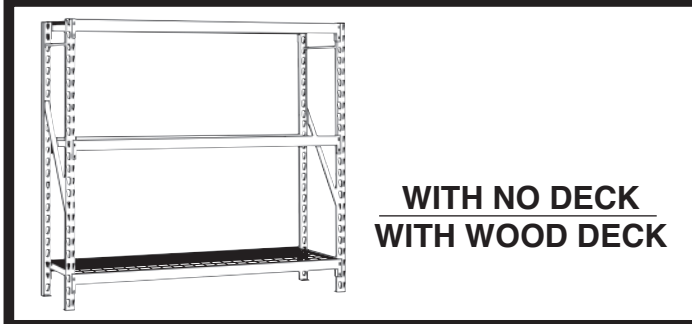

ADD-ON UNITS

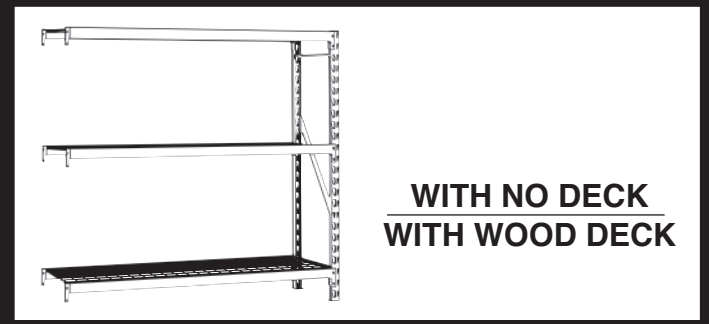

WITH NO DECK

Edsal #	W" x D" x H"	Total List	Total Wt.
ERU602472S	60x24x72	\$333.32	112.0
ERU603672S	60x36x72	\$349.55	116.0
ERU604872S	60x48x72	\$359.70	123.0
ERU722472S	72x24x72	\$355.58	124.0
ERU723672S	72x36x72	\$371.80	128.0
ERU724872S	72x48x72	\$381.97	135.0
ERU962472S	96x24x72	\$400.43	148.0
ERU963672S	96x36x72	\$418.57	152.0
ERU964872S	96x48x72	\$430.44	162.0
ERU602496S	60x24x96	\$381.36	130.0
ERU603696S	60x36x96	\$400.74	138.0
ERU604896S	60x48x96	\$415.00	147.0
ERU722496S	72x24x96	\$403.62	142.0
ERU723696S	72x36x96	\$423.01	150.0
ERU724896S	72x48x96	\$437.27	159.0
ERU962496S	96x24x96	\$448.48	166.0
ERU963696S	96x36x96	\$469.78	174.0
ERU964896S	96x48x96	\$485.72	186.0
ERU6024120S	60x24x120	\$410.84	142.0
ERU6036120S	60x36x120	\$433.49	150.0
ERU6048120S	60x48x120	\$444.96	159.0
ERU7224120S	72x24x120	\$433.11	154.0
ERU7236120S	72x36x120	\$455.75	162.0
ERU7248120S	72x48x120	\$467.22	171.0
ERU9624120S	96x24x120	\$477.69	178.0
ERU9636120S	96x36x120	\$502.51	186.0
ERU9648120S	96x48x120	\$515.69	198.0

WITH NO DECK

Edsal #	W" x D" x H"	Total List	Total Wt.
ERU602472A	60x24x72	\$254.14	89.0
ERU603672A	60x36x72	\$263.20	91.0
ERU604872A	60x48x72	\$269.14	96.0
ERU722472A	72x24x72	\$276.41	101.0
ERU723672A	72x36x72	\$285.47	103.0
ERU724872A	72x48x72	\$291.40	108.0
ERU962472A	96x24x72	\$321.27	125.0
ERU963672A	96x36x72	\$332.24	127.0
ERU964872A	96x48x72	\$339.84	135.0
ERU602496A	60x24x96	\$278.16	98.0
ERU603696A	60x36x96	\$288.81	102.0
ERU604896A	60x48x96	\$296.78	108.0
ERU722496A	72x24x96	\$300.42	110.0
ERU723696A	72x36x96	\$311.07	114.0
ERU724896A	72x48x96	\$319.05	120.0
ERU962496A	96x24x96	\$345.29	134.0
ERU963696A	96x36x96	\$357.83	138.0
ERU964896A	96x48x96	\$367.52	147.0
ERU6024120A	60x24x120	\$292.90	104.0
ERU6036120A	60x36x120	\$305.18	108.0
ERU6048120A	60x48x120	\$311.76	114.0
ERU7224120A	72x24x120	\$315.15	116.0
ERU7236120A	72x36x120	\$327.44	120.0
ERU7248120A	72x48x120	\$334.03	126.0
ERU9624120A	96x24x120	\$360.03	140.0
ERU9636120A	96x36x120	\$374.20	144.0
ERU9648120A	96x48x120	\$382.49	153.0

WITH WOOD DECK

Edsal #	W" x D" x H"	Total List	Total Wt.
ERP602472S	60x24x72	\$406.15	187.0
ERP603672S	60x36x72	\$461.29	227.0
ERP604872S	60x48x72	\$510.45	270.0
ERP722472S	72x24x72	\$447.94	211.0
ERP723672S	72x36x72	\$511.54	260.0
ERP724872S	72x48x72	\$568.91	312.0
ERP962472S	96x24x72	\$512.26	265.0
ERP963672S	96x36x72	\$593.16	329.0
ERP964872S	96x48x72	\$669.05	396.0
ERP602496S	60x24x96	\$454.19	205.0
ERP603696S	60x36x96	\$512.50	249.0
ERP604896S	60x48x96	\$565.77	294.0
ERP722496S	72x24x96	\$496.00	229.0
ERP723696S	72x36x96	\$562.75	282.0
ERP724896S	72x48x96	\$624.23	336.0
ERP962496S	96x24x96	\$560.32	283.0
ERP963696S	96x36x96	\$644.37	351.0
ERP964896S	96x48x96	\$724.36	420.0
ERP6024120S	60x24x120	\$483.68	217.0
ERP6036120S	60x36x120	\$545.25	261.0
ERP6048120S	60x48x120	\$595.73	306.0
ERP7224120S	72x24x120	\$525.47	241.0
ERP7236120S	72x36x120	\$595.50	294.0
ERP7248120S	72x48x120	\$654.19	348.0
ERP9624120S	96x24x120	\$589.80	295.0
ERP9636120S	96x36x120	\$677.11	363.0
ERP9648120S	96x48x120	\$754.33	432.0

WITH WOOD DECK

Edsal #	W" x D" x H"	Total List	Total Wt.
ERP602472A	60x24x72	\$326.97	164.0
ERP603672A	60x36x72	\$374.97	202.0
ERP604872A	60x48x72	\$419.89	243.0
ERP722472A	72x24x72	\$368.76	188.0
ERP723672A	72x36x72	\$425.21	235.0
ERP724872A	72x48x72	\$478.35	285.0
ERP962472A	96x24x72	\$433.09	242.0
ERP963672A	96x36x72	\$506.82	304.0
ERP964872A	96x48x72	\$578.49	369.0
ERP602496A	60x24x96	\$350.99	173.0
ERP603696A	60x36x96	\$400.57	213.0
ERP604896A	60x48x96	\$447.54	255.0
ERP722496A	72x24x96	\$392.80	197.0
ERP723696A	72x36x96	\$450.82	246.0
ERP724896A	72x48x96	\$506.00	297.0
ERP962496A	96x24x96	\$457.11	251.0
ERP963696A	96x36x96	\$532.43	315.0
ERP964896A	96x48x96	\$606.14	381.0
ERP6024120A	60x24x120	\$365.74	179.0
ERP6036120A	60x36x120	\$416.94	219.0
ERP6048120A	60x48x120	\$462.52	261.0
ERP7224120A	72x24x120	\$407.54	203.0
ERP7236120A	72x36x120	\$467.19	252.0
ERP7248120A	72x48x120	\$520.99	303.0
ERP9624120A	96x24x120	\$471.86	257.0
ERP9636120A	96x36x120	\$548.80	321.0
ERP9648120A	96x48x120	\$621.12	387.0

ADDITIONAL LEVELS WITH NO DECK

Edsal #	W" x D"	Total List	Total Wt.
ERU6024	60x24	\$58.32	22.0
ERU6036	60x36	\$58.96	22.0
ERU6048	60x48	\$59.52	23.0
ERU7224	72x24	\$65.76	26.0
ERU7236	72x36	\$66.36	26.0
ERU7248	72x48	\$66.94	27.0
ERU9624	96x24	\$80.70	34.0
ERU9636	96x36	\$81.97	34.0
ERU9648	96x48	\$83.10	36.0

ADDITIONAL LEVELS WITH WOOD DECK

Edsal #	W" x D"	Total List	Total Wt.
ERP6024	60x24	\$85.05	47.0
ERP6036	60x36	\$99.07	59.0
ERP6048	60x48	\$113.03	72.0
ERP7224	72x24	\$101.43	55.0
ERP7236	72x36	\$118.70	70.0
ERP7248	72x48	\$135.75	86.0
ERP9624	96x24	\$122.87	73.0
ERP9636	96x36	\$145.89	93.0
ERP9648	96x48	\$169.12	114.0

**CLASS
A**

WELDED FRAME BULK E-RACK



CATALOG PAGE 63

STARTER UNITS

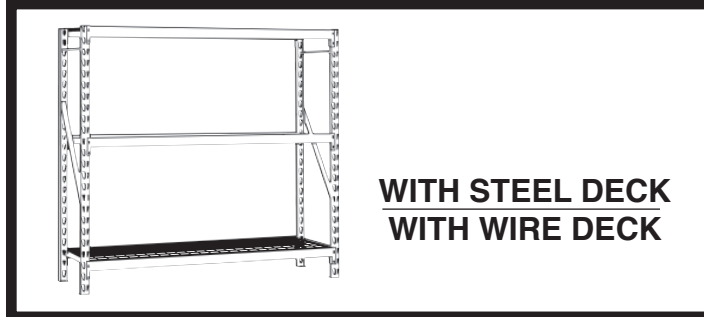

**WITH STEEL DECK
WITH WIRE DECK**

ADD-ON UNITS

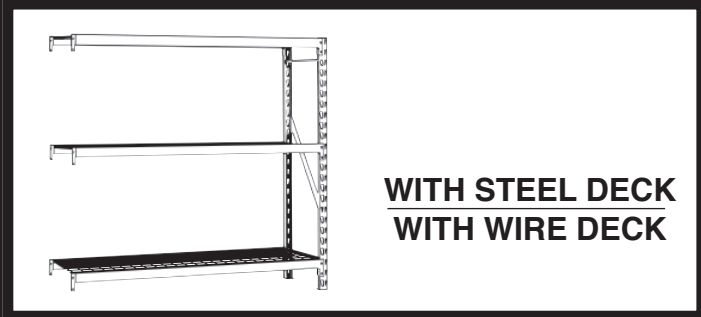

**WITH STEEL DECK
WITH WIRE DECK**

WITH STEEL DECK

Edsal #	W" x D" x H"	Total List	Total Wt.
ERS602472S	60x24x72	\$446.87	175.0
ERS603672S	60x36x72	\$521.59	215.0
ERS604872S	60x48x72	\$587.50	252.0
ERS722472S	72x24x72	\$491.00	202.0
ERS723672S	72x36x72	\$576.44	248.0
ERS724872S	72x48x72	\$652.67	291.0
ERS962472S	96x24x72	\$571.67	247.0
ERS963672S	96x36x72	\$676.62	305.0
ERS964872S	96x48x72	\$773.28	360.0
ERS602496S	60x24x96	\$494.90	193.0
ERS603696S	60x36x96	\$572.80	237.0
ERS604896S	60x48x96	\$642.78	276.0
ERS722496S	72x24x96	\$539.05	220.0
ERS723696S	72x36x96	\$627.64	270.0
ERS724896S	72x48x96	\$707.96	315.0
ERS962496S	96x24x96	\$619.73	265.0
ERS963696S	96x36x96	\$727.81	327.0
ERS964896S	96x48x96	\$828.58	384.0
ERS6024120S	60x24x120	\$524.40	205.0
ERS6036120S	60x36x120	\$605.53	249.0
ERS6048120S	60x48x120	\$672.76	288.0
ERS7224120S	72x24x120	\$568.54	232.0
ERS7236120S	72x36x120	\$660.39	282.0
ERS7248120S	72x48x120	\$737.92	327.0
ERS9624120S	96x24x120	\$649.21	277.0
ERS9636120S	96x36x120	\$760.56	339.0
ERS9648120S	96x48x120	\$858.54	396.0

WITH STEEL DECK

Edsal #	W" x D" x H"	Total List	Total Wt.
ERS602472A	60x24x72	\$367.69	152.0
ERS603672A	60x36x72	\$435.25	190.0
ERS604872A	60x48x72	\$496.90	225.0
ERS722472A	72x24x72	\$411.84	179.0
ERS723672A	72x36x72	\$490.10	223.0
ERS724872A	72x48x72	\$562.09	264.0
ERS962472A	96x24x72	\$492.50	224.0
ERS963672A	96x36x72	\$590.27	280.0
ERS964872A	96x48x72	\$682.72	333.0
ERS602496A	60x24x96	\$391.71	161.0
ERS603696A	60x36x96	\$460.86	201.0
ERS604896A	60x48x96	\$524.58	237.0
ERS722496A	72x24x96	\$435.86	188.0
ERS723696A	72x36x96	\$515.70	234.0
ERS724896A	72x48x96	\$589.73	276.0
ERS962496A	96x24x96	\$516.52	233.0
ERS963696A	96x36x96	\$615.88	291.0
ERS964896A	96x48x96	\$710.35	345.0
ERS6024120A	60x24x120	\$406.46	167.0
ERS6036120A	60x36x120	\$477.22	207.0
ERS6048120A	60x48x120	\$539.55	243.0
ERS7224120A	72x24x120	\$450.59	194.0
ERS7236120A	72x36x120	\$532.07	240.0
ERS7248120A	72x48x120	\$604.72	282.0
ERS9624120A	96x24x120	\$531.26	239.0
ERS9636120A	96x36x120	\$632.25	297.0
ERS9648120A	96x48x120	\$725.35	351.0

WITH WIRE DECK

Edsal #	W" x D" x H"	Total List	Total Wt.
ERW602472S	60x24x72	\$576.62	154.0
ERW603672S	60x36x72	\$718.12	179.0
ERW604872S	60x48x72	\$853.74	216.0
ERW722472S	72x24x72	\$650.85	178.0
ERW723672S	72x36x72	\$778.92	197.0
ERW724872S	72x48x72	\$899.44	243.0
ERW962472S	96x24x72	\$812.53	214.0
ERW963672S	96x36x72	\$970.42	254.0
ERW964872S	96x48x72	\$1,139.84	306.0
ERW602496S	60x24x96	\$624.67	172.0
ERW603696S	60x36x96	\$769.35	201.0
ERW604896S	60x48x96	\$909.03	240.0
ERW722496S	72x24x96	\$698.90	196.0
ERW723696S	72x36x96	\$830.13	219.0
ERW724896S	72x48x96	\$954.75	267.0
ERW962496S	96x24x96	\$860.57	232.0
ERW963696S	96x36x96	\$1,021.62	276.0
ERW964896S	96x48x96	\$1,195.15	330.0
ERW6024120S	60x24x120	\$654.16	184.0
ERW6036120S	60x36x120	\$802.07	213.0
ERW6048120S	60x48x120	\$939.01	252.0
ERW7224120S	72x24x120	\$728.40	208.0
ERW7236120S	72x36x120	\$862.86	231.0
ERW7248120S	72x48x120	\$984.71	279.0
ERW9624120S	96x24x120	\$890.06	244.0
ERW9636120S	96x36x120	\$1,054.35	288.0
ERW9648120S	96x48x120	\$1,225.10	342.0

WITH WIRE DECK

Edsal #	W" x D" x H"	Total List	Total Wt.
ERW602472A	60x24x72	\$497.45	131.0
ERW603672A	60x36x72	\$631.80	154.0
ERW604872A	60x48x72	\$763.17	189.0
ERW722472A	72x24x72	\$571.68	155.0
ERW723672A	72x36x72	\$692.59	172.0
ERW724872A	72x48x72	\$808.87	216.0
ERW962472A	96x24x72	\$733.36	191.0
ERW963672A	96x36x72	\$884.08	229.0
ERW964872A	96x48x72	\$1,049.28	279.0
ERW602496A	60x24x96	\$521.47	140.0
ERW603696A	60x36x96	\$657.40	165.0
ERW604896A	60x48x96	\$790.82	201.0
ERW722496A	72x24x96	\$595.70	164.0
ERW723696A	72x36x96	\$718.17	183.0
ERW724896A	72x48x96	\$836.52	228.0
ERW962496A	96x24x96	\$757.37	200.0
ERW963696A	96x36x96	\$909.69	240.0
ERW964896A	96x48x96	\$1,076.92	291.0
ERW6024120A	60x24x120	\$536.22	146.0
ERW6036120A	60x36x120	\$673.77	171.0
ERW6048120A	60x48x120	\$805.80	207.0
ERW7224120A	72x24x120	\$610.45	170.0
ERW7236120A	72x36x120	\$734.55	189.0
ERW7248120A	72x48x120	\$740.44	234.0
ERW9624120A	96x24x120	\$772.13	206.0
ERW9636120A	96x36x120	\$926.06	246.0
ERW9648120A	96x48x120	\$1,091.92	297.0

ADDITIONAL LEVELS WITH STEEL DECK

Edsal #	W" x D"	Total List	Total Wt.
ERS6024	60x24	\$96.17	43.0
ERS6036	60x36	\$116.31	55.0
ERS6048	60x48	\$135.45	66.0
ERS7224	72x24	\$110.90	52.0
ERS7236	72x36	\$134.58	66.0
ERS7248	72x48	\$157.16	79.0
ERS9624	96x24	\$137.78	67.0
ERS9636	96x36	\$167.98	85.0
ERS9648	96x48	\$197.37	102.0

ADDITIONAL LEVELS WITH WIRE DECK

Edsal #	W" x D" x H"	Total List	Total Wt.
ERW6024	60x24	\$139.42	37.0
ERW6036	60x36	\$181.81	42.0
ERW6048	60x48	\$224.20	53.0
ERW7224	72x24	\$164.16	44.0
ERW7236	72x36	\$202.06	49.0
ERW7248	72x48	\$239.43	63.0
ERW9624	96x24	\$218.06	56.0
ERW9636	96x36	\$265.92	68.0
ERW9648	96x48	\$319.56	84.0

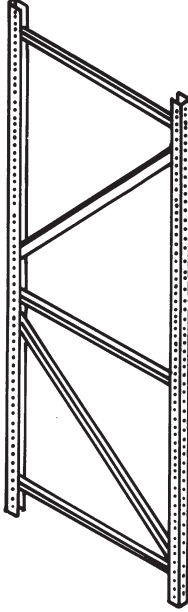

RACK END

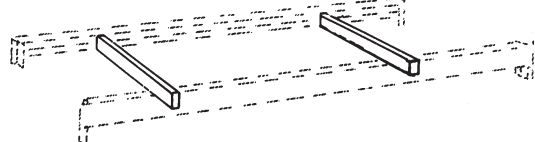
TIE BARS

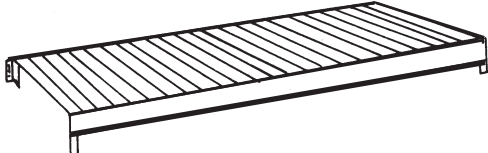

STEEL DECKING
(Decking does not include beams or tie bars)

RACK ENDS

Product Number	Product Size D" x H"	List Price Per Item	Shipping Wt. (Lbs.)
BW2003	24 x 72	89.95	23
BW2015	24 x 96	117.22	32
BW2027	24 x 120	134.00	38
BW2007	36 x 72	98.09	25
BW2019	36 x 96	127.17	36
BW2031	36 x 120	145.75	42
BW2011	48 x 72	102.88	27
BW2023	48 x 96	134.32	39
BW2035	48 x 120	151.33	45

BEAMS

Product Number	Product Size Width	List Price Per Item	Shipping Wt. (Lbs.)
BW2054	60"	40.72	10
BW2055	72"	44.45	12
BW2056	96"	51.36	15

TIE BARS

Product Number	Product Size Depth	List Price Per Item	Shipping Wt. (Lbs.)
BWTB24	24"	5.73	2
BWTB36	36"	7.60	2
BWTB48	48"	9.97	3

STEEL DECKING

Product Number	Product Size W" x D"	List Price Per Item	Shipping Wt. (Lbs.)
BWD2460	60 X 24	47.96	23
BWD2472	72 X 24	56.39	28
BWD2496	96 X 24	74.42	37
BWD3660	60 X 36	71.23	35
BWD3672	72 X 36	83.77	42
BWD3696	96 X 36	109.31	55
BWD4860	60 X 48	93.34	46
BWD4872	72 X 48	109.86	55
BWD4896	96 X 48	143.26	72



PARTICLE BOARD SHELF DECKING

Product #	Size (W" x D")	List Ea.	Wt.
RLPB 2460	60 x 24	26.72	25
RLPB 3660	60 x 36	40.12	37
RLPB 4860	60 x 48	53.51	49
RLPB 2472	72 x 24	32.00	29
RLPB 3672	72 x 36	48.02	44
RLPB 4872	72 x 48	63.93	59
RLPB 2496	96 x 24	42.16	39
RLPB 3696	96 x 36	63.93	59
RLPB 4896	96 x 48	86.03	78

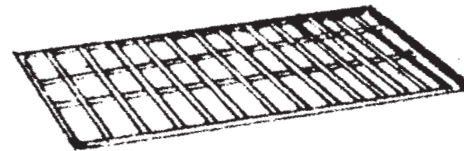

GALVANIZED WIRE SHELF DECKING

Product #	Size (W" x D")	List Ea.	Wt.
RWD 2460	60 x 24	100.77	16
RWD 3660	60 x 36	136.45	23
RWD 4860	60 x 48	173.53	34
RWD 2472	72 x 24	117.94	20
RWD 3672	72 x 36	161.72	25
RWD 4872	72 x 48	204.87	39
RWD 2496	96 x 24	167.14	26
RWD 3696	96 x 36	222.41	38
RWD 4896	96 x 48	284.38	54

**CLASS
A**

BULK STORAGE

Z-BEAM WELDED FRAME UNITS



CATALOG PAGE 65

STARTER UNITS



**WITH NO DECK
WITH WOOD DECK**

ADD-ON UNITS

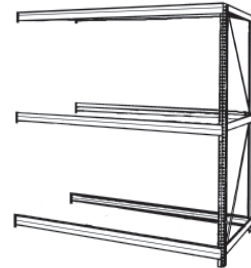

**WITH NO DECK
WITH WOOD DECK**

WITH NO DECK

Edsal #	W" x D" x H"	Total List	Total Wt.
GB504407	60x24x72	\$441.50	112.0
GB504408	60x36x72	\$463.37	116.0
GB504409	60x48x72	\$480.05	123.0
GB504410	72x24x72	\$481.00	130.0
GB504411	72x36x72	\$508.44	134.0
GB504412	72x48x72	\$532.23	144.0
GB504413	96x24x72	\$539.13	154.0
GB504414	96x36x72	\$572.81	158.0
GB504415	96x48x72	\$603.71	171.0
GB504416	60x24x96	\$496.04	130.0
GB504417	60x36x96	\$521.52	138.0
GB504418	60x48x96	\$542.93	147.0
GB504419	72x24x96	\$535.54	148.0
GB504420	72x36x96	\$566.59	156.0
GB504421	72x48x96	\$595.13	168.0
GB504422	96x24x96	\$594.27	172.0
GB504423	96x36x96	\$630.96	180.0
GB504424	96x48x96	\$666.59	195.0
GB504425	60x24x120	\$529.58	142.0
GB504426	60x36x120	\$558.67	150.0
GB504427	60x48x120	\$576.93	159.0
GB504428	72x24x120	\$569.07	160.0
GB504429	72x36x120	\$603.76	168.0
GB504430	72x48x120	\$629.12	180.0
GB504431	96x24x120	\$627.85	184.0
GB504432	96x36x120	\$668.13	192.0
GB504433	96x48x120	\$700.61	207.0

WITH NO DECK

Edsal #	W" x D" x H"	Total List	Total Wt.
GB504434	60x24x72	\$351.55	89.0
GB504435	60x36x72	\$365.29	91.0
GB504436	60x48x72	\$377.18	96.0
GB504437	72x24x72	\$391.03	107.0
GB504438	72x36x72	\$410.34	109.0
GB504439	72x48x72	\$429.34	117.0
GB504440	96x24x72	\$449.82	131.0
GB504441	96x36x72	\$474.72	133.0
GB504442	96x48x72	\$500.82	144.0
GB504443	60x24x96	\$378.82	98.0
GB504444	60x36x96	\$394.35	102.0
GB504445	60x48x96	\$408.62	108.0
GB504446	72x24x96	\$418.30	116.0
GB504447	72x36x96	\$439.43	120.0
GB504448	72x48x96	\$460.80	129.0
GB504449	96x24x96	\$477.09	140.0
GB504450	96x36x96	\$503.80	144.0
GB504451	96x48x96	\$532.28	156.0
GB504452	60x24x120	\$395.58	104.0
GB504453	60x36x120	\$412.92	108.0
GB504454	60x48x120	\$425.61	114.0
GB504455	72x24x120	\$435.08	122.0
GB504456	72x36x120	\$458.01	126.0
GB504457	72x48x120	\$477.80	135.0
GB504458	96x24x120	\$493.86	146.0
GB504459	96x36x120	\$522.38	150.0
GB504460	96x48x120	\$549.28	162.0

WITH WOOD DECK

Edsal #	W" x D" x H"	Total List	Total Wt.
GB504281	60x24x72	\$525.19	187.0
GB504282	60x36x72	\$586.01	227.0
GB504283	60x48x72	\$641.47	270.0
GB504284	72x24x72	\$580.50	217.0
GB504285	72x36x72	\$654.48	266.0
GB504286	72x48x72	\$724.53	321.0
GB504287	96x24x72	\$669.46	271.0
GB504288	96x36x72	\$765.72	335.0
GB504289	96x48x72	\$860.76	405.0
GB504290	60x24x96	\$580.56	205.0
GB504291	60x36x96	\$645.05	249.0
GB504292	60x48x96	\$705.32	294.0
GB504293	72x24x96	\$635.85	235.0
GB504294	72x36x96	\$713.51	288.0
GB504295	72x48x96	\$788.36	345.0
GB504296	96x24x96	\$724.82	289.0
GB504297	96x36x96	\$824.75	357.0
GB504298	96x48x96	\$924.60	429.0
GB504299	60x24x120	\$614.61	217.0
GB504300	60x36x120	\$682.76	261.0
GB504301	60x48x120	\$739.84	306.0
GB504302	72x24x120	\$669.90	247.0
GB504303	72x36x120	\$751.25	300.0
GB504304	72x48x120	\$822.87	357.0
GB504305	96x24x120	\$758.88	301.0
GB504306	96x36x120	\$862.46	369.0
GB504307	96x48x120	\$959.11	441.0

WITH WOOD DECK

Edsal #	W" x D" x H"	Total List	Total Wt.
GB504308	60x24x72	\$433.89	164.0
GB504309	60x36x72	\$486.45	202.0
GB504310	60x48x72	\$537.05	243.0
GB504311	72x24x72	\$489.17	194.0
GB504312	72x36x72	\$554.92	241.0
GB504313	72x48x72	\$620.10	294.0
GB504314	96x24x72	\$578.16	248.0
GB504315	96x36x72	\$666.14	310.0
GB504316	96x48x72	\$756.33	378.0
GB504317	60x24x96	\$461.56	173.0
GB504318	60x36x96	\$515.96	213.0
GB504319	60x48x96	\$568.97	255.0
GB504320	72x24x96	\$516.85	203.0
GB504321	72x36x96	\$584.44	252.0
GB504322	72x48x96	\$652.01	306.0
GB504323	96x24x96	\$605.83	257.0
GB504324	96x36x96	\$695.67	321.0
GB504325	96x48x96	\$788.24	390.0
GB504326	60x24x120	\$478.60	179.0
GB504327	60x36x120	\$534.81	219.0
GB504328	60x48x120	\$586.23	261.0
GB504329	72x24x120	\$533.88	209.0
GB504330	72x36x120	\$603.29	258.0
GB504331	72x48x120	\$669.27	312.0
GB504332	96x24x120	\$622.87	263.0
GB504333	96x36x120	\$714.52	327.0
GB504334	96x48x120	\$805.51	396.0

ADDITIONAL LEVELS WITH NO DECK

Edsal #	W" x D"	Total List	Total Wt.
GB504461	60x24	\$87.20	22.0
GB504461	60x36	\$87.20	22.0
GB504461	60x48	\$87.20	22.0
GB504462	72x24	\$100.36	28.0
GB504462	72x36	\$100.36	28.0
GB504462	72x48	\$100.36	28.0
GB504463	96x24	\$119.96	36.0
GB504463	96x36	\$119.96	36.0
GB504463	96x48	\$119.96	36.0

ADDITIONAL LEVELS WITH WOOD DECK

Edsal #	W" x D"	Total List	Total Wt.
GB504335	60x24	\$114.18	47.0
GB504336	60x36	\$128.96	59.0
GB504337	60x48	\$144.20	72.0
GB504338	72x24	\$132.63	57.0
GB504339	72x36	\$151.79	72.0
GB504340	72x48	\$171.89	89.0
GB504341	96x24	\$162.28	75.0
GB504342	96x36	\$188.86	95.0
GB504343	96x48	\$217.30	117.0

STARTER UNITS



**WITH STEEL DECK
WITH WIRE DECK**

ADD-ON UNITS



**WITH STEEL DECK
WITH WIRE DECK**

WITH STEEL DECK

Edsal #	W" x D" x H"	Total List	Total Wt.
GB504344	60x24x72	\$585.40	181.0
GB504345	60x36x72	\$677.06	221.0
GB504346	60x48x72	\$760.05	261.0
GB504347	72x24x72	\$650.16	214.0
GB504348	72x36x72	\$759.74	260.0
GB504349	72x48x72	\$861.79	309.0
GB504350	96x24x72	\$763.03	265.0
GB504351	96x36x72	\$900.73	323.0
GB504352	96x48x72	\$1,033.49	387.0
GB504353	60x24x96	\$639.93	199.0
GB504354	60x36x96	\$735.22	243.0
GB504355	60x48x96	\$822.94	285.0
GB504356	72x24x96	\$704.69	232.0
GB504357	72x36x96	\$817.91	282.0
GB504358	72x48x96	\$924.70	333.0
GB504359	96x24x96	\$817.56	283.0
GB504360	96x36x96	\$958.88	345.0
GB504361	96x48x96	\$1,096.39	411.0
GB504362	60x24x120	\$673.47	211.0
GB504363	60x36x120	\$772.36	255.0
GB504364	60x48x120	\$859.96	297.0
GB504365	72x24x120	\$738.24	244.0
GB504366	72x36x120	\$855.08	294.0
GB504367	72x48x120	\$958.68	345.0
GB504368	96x24x120	\$851.12	295.0
GB504369	96x36x120	\$996.05	357.0
GB504370	96x48x120	\$1,130.40	423.0

WITH STEEL DECK

Edsal #	W" x D" x H"	Total List	Total Wt.
GB504371	60x24x72	\$495.45	158.0
GB504372	60x36x72	\$578.96	196.0
GB504373	60x48x72	\$657.18	234.0
GB504374	72x24x72	\$560.21	191.0
GB504375	72x36x72	\$661.67	235.0
GB504376	72x48x72	\$758.93	282.0
GB504377	96x24x72	\$673.08	242.0
GB504378	96x36x72	\$802.64	298.0
GB504379	96x48x72	\$930.62	360.0
GB504380	60x24x96	\$522.71	167.0
GB504381	60x36x96	\$608.04	207.0
GB504382	60x48x96	\$688.64	246.0
GB504383	72x24x96	\$587.49	200.0
GB504384	72x36x96	\$690.74	246.0
GB504385	72x48x96	\$790.36	294.0
GB504386	96x24x96	\$700.36	251.0
GB504387	96x36x96	\$831.72	309.0
GB504388	96x48x96	\$962.07	372.0
GB504389	60x24x120	\$539.10	173.0
GB504390	60x36x120	\$626.62	213.0
GB504391	60x48x120	\$705.63	252.0
GB504392	72x24x120	\$604.25	206.0
GB504393	72x36x120	\$709.32	252.0
GB504394	72x48x120	\$807.38	300.0
GB504395	96x24x120	\$717.12	257.0
GB504396	96x36x120	\$850.30	315.0
GB504397	96x48x120	\$979.08	378.0

WITH WIRE DECK

Edsal #	W" x D" x H"	Total List	Total Wt.
GB504464	60x24x72	\$734.77	160.0
GB504465	60x36x72	\$872.76	185.0
GB504466	60x48x72	\$1,000.60	225.0
GB504467	72x24x72	\$834.80	190.0
GB504468	72x36x72	\$993.58	209.0
GB504469	72x48x72	\$1,146.85	261.0
GB504470	96x24x72	\$1,041.21	232.0
GB504471	96x36x72	\$1,240.08	272.0
GB504472	96x48x72	\$1,456.85	333.0
GB504473	60x24x96	\$798.30	178.0
GB504474	60x36x96	\$930.90	207.0
GB504475	60x48x96	\$1,063.50	249.0
GB504476	72x24x96	\$889.34	208.0
GB504477	72x36x96	\$1,051.74	231.0
GB504478	72x48x96	\$1,209.74	285.0
GB504479	96x24x96	\$1,095.75	250.0
GB504480	96x36x96	\$1,298.22	294.0
GB504481	96x48x96	\$1,420.99	357.0
GB504482	60x24x120	\$831.85	190.0
GB504483	60x36x120	\$968.06	219.0
GB504484	60x48x120	\$1,097.51	261.0
GB504485	72x24x120	\$922.90	220.0
GB504486	72x36x120	\$1,088.90	243.0
GB504487	72x48x120	\$1,243.74	297.0
GB504488	96x24x120	\$1,129.30	262.0
GB504489	96x36x120	\$1,335.37	306.0
GB504490	96x48x120	\$1,553.75	369.0

WITH WIRE DECK

Edsal #	W" x D"	Total List	Total Wt.
GB504491	60x24x72	\$653.83	137.0
GB504492	60x36x72	\$774.66	160.0
GB504493	60x48x72	\$897.74	198.0
GB504494	72x24x72	\$744.87	167.0
GB504495	72x36x72	\$895.49	184.0
GB504496	72x48x72	\$1,043.97	234.0
GB504497	96x24x72	\$951.27	209.0
GB504498	96x36x72	\$1,141.99	247.0
GB504499	96x48x72	\$1,353.98	306.0
GB504500	60x24x96	\$681.09	146.0
GB504501	60x36x96	\$803.74	171.0
GB504502	60x48x96	\$929.19	210.0
GB504503	72x24x96	\$772.13	176.0
GB504504	72x36x96	\$924.57	195.0
GB504505	72x48x96	\$1,075.41	246.0
GB504506	96x24x96	\$978.54	218.0
GB504507	96x36x96	\$1,171.07	258.0
GB504508	96x48x96	\$1,385.43	318.0
GB504509	60x24x120	\$697.86	152.0
GB504510	60x36x120	\$822.32	177.0
GB504511	60x48x120	\$946.19	216.0
GB504512	72x24x120	\$788.90	182.0
GB504513	72x36x120	\$943.16	201.0
GB504514	72x48x120	\$1,092.41	252.0
GB504515	96x24x120	\$995.30	224.0
GB504516	96x36x120	\$1,189.64	264.0
GB504517	96x48x120	\$1,402.43	324.0

ADDITIONAL LEVELS WITH STEEL DECK

Edsal #	W" x D"	Total List	Total Wt.
GB504398	60x24	\$135.16	45.0
GB504399	60x36	\$160.30	57.0
GB504400	60x48	\$184.77	69.0
GB504401	72x24	\$156.75	56.0
GB504402	72x36	\$159.64	70.0
GB504403	72x48	\$218.68	85.0
GB504404	96x24	\$194.38	73.0
GB504405	96x36	\$234.85	91.0
GB504406	96x48	\$275.91	111.0

ADDITIONAL LEVELS WITH WIRE DECK

Edsal #	W" x D" x H"	Total List	Total Wt.
GB504518	60x24	\$187.95	38.0
GB504519	60x36	\$225.52	45.0
GB504520	60x48	\$264.96	57.0
GB504521	72x24	\$218.30	48.0
GB504522	72x36	\$265.80	53.0
GB504523	72x48	\$313.70	69.0
GB504524	96x24	\$287.10	62.0
GB504525	96x36	\$347.97	74.0
GB504526	96x48	\$417.03	93.0

**CLASS
A**

WELDED FRAME RECORDS STORAGE RACK



CATALOG PAGES 66
less boxes (see page 26 for boxes)



Product Number	Description	W" x D" x H"	List Each	Weight Each
RSS6018	3 Shelf, 28 Box	60 x 18 x 72	382.05	187
RSS6036	3 Shelf, 56 Box	60 x 36 x 72	466.53	227
RSS7218	3 Shelf, 35 Box	72 x 18 x 72	412.85	211
RSS7236	3 Shelf, 70 Box	72 x 36 x 72	508.99	260
RSS9618	3 Shelf, 49 Box	96 x 18 x 72	394.41	265
RSS9636	3 Shelf, 98 Box	96 x 36 x 72	581.68	329
RSA6018	3 Shelf Add-On, 28 Box	60 x 18 x 72	314.30	164
RSA6036	3 Shelf Add-On, 56 Box	60 x 36 x 72	380.67	202
RSA7218	3 Shelf Add-On, 35 Box	72 x 18 x 72	345.08	188
RSA7236	3 Shelf Add-On, 70 Box	72 x 36 x 72	423.11	235
RSA9618	3 Shelf Add-On, 49 Box	96 x 18 x 72	396.22	242
RSA9636	3 Shelf Add-On, 98 Box	76 x 36 x 72	491.41	304

**CLASS
A**

TIRE RACK



CATALOG PAGE 66

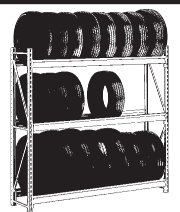

Product Number	Description	W" x D" x H"	List Each	Weight Each
TRWS6018	3 Shelf Starter, 21 Tire	60 x 18 x 72	305.64	93
TRWS7218	3 Shelf Starter, 27 Tire	72 x 18 x 72	335.20	103
TRWS9618	3 Shelf Starter, 36 Tire	96 x 18 x 72	387.73	123
TRWA6018	3 Shelf Add-On, 21 Tire	60 x 18 x 72	241.27	74
TRWA7218	3 Shelf Add-On, 27 Tire	72 x 18 x 72	255.35	74
TRWA9618	3 Shelf Add-On, 36 Tire	96 x 18 x 72	307.89	105

**CLASS
A**

WELDED FRAME IN-LINE SHELVING



CATALOG PAGE 67

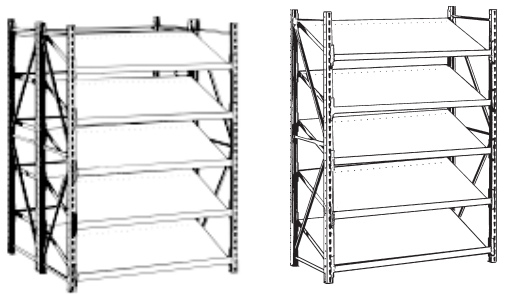

Product Number	Description	W" x D" x H"	List Each	Weight Each
INSS2700	Single Straight Starter	52 x 26 x 78	599.36	205
INSA2701	Single Straight Add-On	50 x 26 x 78	531.16	180
INSS2702	Double Straight Starter	52 x 52 x 78	1,198.82	210
INSA2703	Double Straight Add-On	50 x 52 x 78	1,062.27	360
INDSTS2704	Double Straight/Tilt Starter	52 x 50 x 78	1,196.09	407
INDSTA2705	Double Straight/Tilt Add-On	50 x 50 x 78	1,060.95	358
INSTS2706	Single Tilt Starter	52 x 24 x 78	596.71	202
INSTA2707	Single Tilt Add-On	50 x 24 x 78	529.77	178
INDTS2708	Double Tilt Starter	52 x 48 x 78	1,001.63	404
INDTA2709	Double Tilt Add-On	50 48 x 78	867.76	356

**CLASS
A**

NSF APPROVED WELDED FRAME STORAGE RACK with wire decking



CATALOG PAGE 68

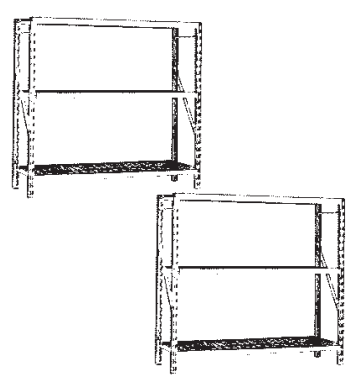

Product #	Description	W" x D" x H"	List Ea.	Wt. Ea.	Additional Shelf Levels			
Product #	W" x D"	List Ea.	Wt. Ea.					
ERX601872S	3 Level Starter	60 x 18 x 72	290.08	148	ERX6018	60 x 18	75.74	24
ERX602472S	3 Level Starter	60 x 24 x 72	320.39	154	ERX6024	60 x 24	84.44	28
ERX721872S	3 Level Starter	72 x 18 x 72	325.30	160	ERX7218	72 x 18	81.43	35
ERX722472S	3 Level Starter	72 x 24 x 72	358.23	200	ERX7224	72 x 24	89.09	40
ERX723672S	3 Level Starter	72 x 36 x 72	400.72	220	ERX7236	72 x 36	110.70	43
ERX962496S	3 Level Starter	96 x 24 x 96	439.52	320	ERX9624	96 x 24	110.46	50
ERX963696S	3 Level Starter	96 x 36 x 96	515.00	340	ERX9636	96 x 36	141.50	54
ERX601872A	3 Level Add-On	60 x 18 x 72	253.94	120				
ERX602472A	3 Level Add-On	60 x 24 x 72	281.07	124				
ERX721872A	3 Level Add-On	72 x 18 x 72	278.96	130				
ERX722472A	3 Level Add-On	72 x 24 x 72	307.55	160				
ERX723672A	3 Level Add-On	72 x 36 x 72	351.81	190				
ERX962496A	3 Level Add-On	96 x 24 x 96	372.66	270				
ERX963696A	3 Level Add-On	96 x 36 x 96	444.31	310				



**CLASS
E**

STOR MASTER PALLET RACK



CATALOG PAGES 71-72

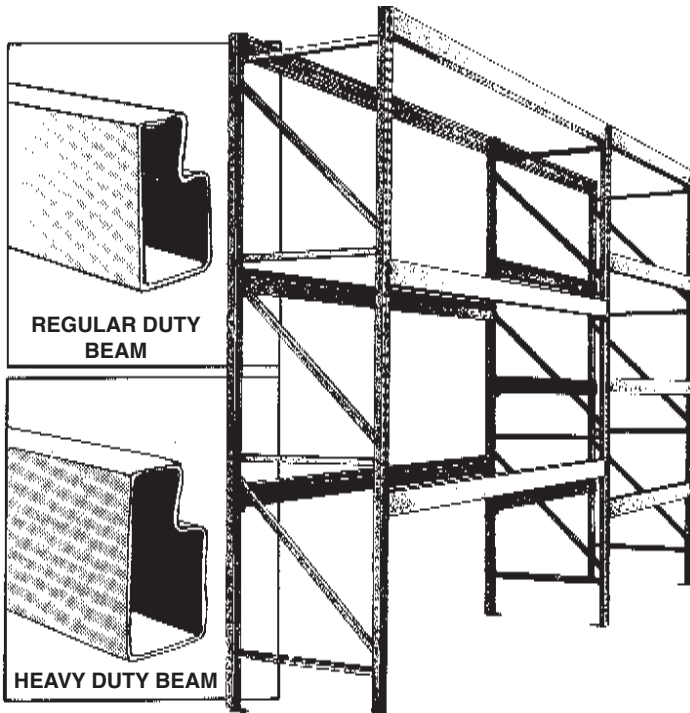

REGULAR DUTY BEAM

HEAVY DUTY BEAM

18,000 Lb. CAP FRAME

25,000 Lb. CAP FRAME

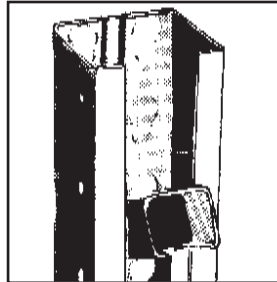
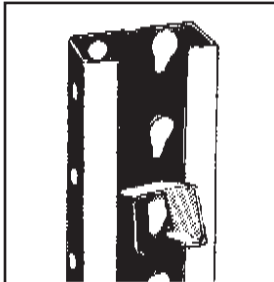

REGULAR DUTY BEAMS

Product No.	Clear Span	Capacity	List Price (Each)	Shpg. Wt. (Lbs.)
RB212	96"	4578 Lbs.	-	29
RB213	108"	3880 Lbs.	-	32

HEAVY DUTY BEAMS

Product No.	Clear Span	Capacity Per Pair	List Price (Each)	Shpg. Wt. (Lbs.)
RB214	96"	5264 Lbs.	90.59	23
RB215	108"	4734 Lbs.	101.49	27
RB232	120"	4090 Lbs.	124.96	32

18,000 Lb. CAP FRAME

Product No.	Product Size D" x H'	List Price (Each)	Shpg. Wt. (Lbs.)
RF200	36 x 96	-	50
RF201	42 x 96	-	52
RF202	36 x 120	-	60
RF203	42 x 120	-	62
RF204	36 x 144	-	74
RF205	42 x 144	-	77

25,000 Lb. CAP FRAME

Product No.	Product Size D" x H'	List Price (Each)	Shpg. Wt. (Lbs.)
DISCONTINUED	36 x 96	-	55
RF207	42 x 96	177.36	45
DISCONTINUED	36 x 120	-	66
RF209	42 x 120	199.46	56
DISCONTINUED	36 x 144	-	81
RF211	42 x 144	243.84	67

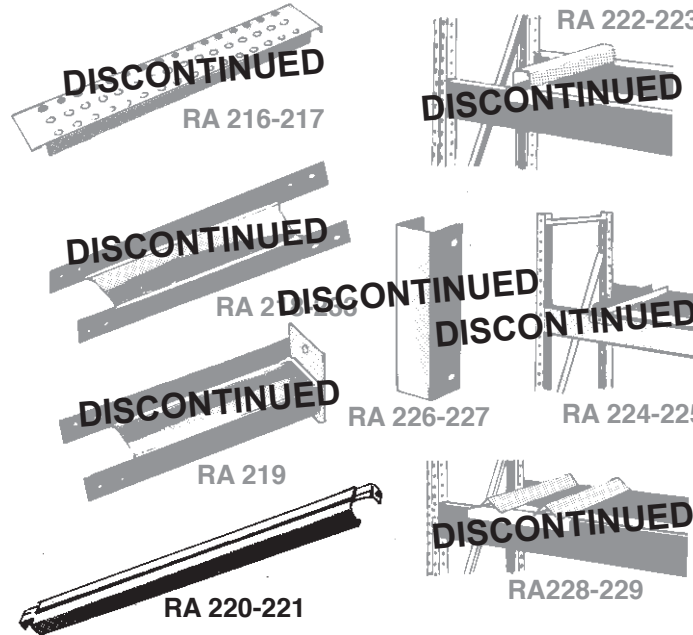

RA 222-223

DISCONTINUED

RA 216-217

DISCONTINUED

DISCONTINUED

RA 219

DISCONTINUED

RA 226-227

RA 224-225

DISCONTINUED

RA 219

DISCONTINUED

RA 220-221

RA228-229

ACCESSORIES

Product No.	Product Description	List Price (Each)	Shpg. Wt. (Lbs.)
RA216	Perforated Modular Deck 6"W x 36"D	-	-
RA217	Perforated Modular Deck 6"W x 42"D	-	-
RA218	Row Spacer 6"	-	2
RA233	Row Spacer 6"	-	3
RA219	Wall Tie Bar 6"	-	2
RA220	Double Flanged Cross Bar 36"D	-	5
RA221	Double Flanged Cross Bar 42"D	22.22	6
RA222	Fork Entry Bar 36"D	-	9
RA223	Fork Entry Bar 42"D	-	10
RA224	Skid Channel 36"D	-	12
RA225	Skid Channel 42"D	-	14
RA226	Skid Channel 42"D	-	4
RA227	Frame Guard 24"H	-	8
RA228	Drum Coil Bed 36"D	-	16
RA229	Drum Coil Bed 42"D	-	18
RA230	Splicing Section for 1 5/8" Frame	-	3
RA231	Splicing Section for 3" Frame	-	4

CLASS F

HAND TRUCKS



CATALOG PAGE 74

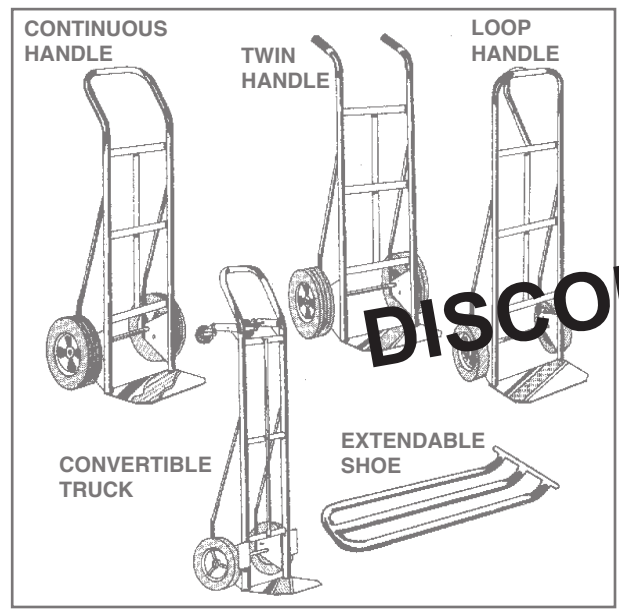

Product Number	Caster Size	Description	List Price Ea.	Shpg. Wt.
CONTINUOUS HANDLE				
HT 6700	8"	300 Lb. Capacity	-	25
HT 6701	10"	500 Lb. Capacity	-	32
TWIN HANDLE				
HT 6702	10"	500 Lb. Capacity	-	32
LOOP HANDLE				
HT 6703	10"	500 Lb. Capacity	-	33
CONVERTIBLE TRUCK				
HT 6704	8"	300 Lb. Capacity	-	32
HT 6705	10"	500 Lb. Capacity	-	41
ALUMINUM TWIN HANDLE				
HT 6706	8"	500 Lb. Capacity	-	24
EXTENDABLE SHOE ACCESSORY KIT				
HT 6707		Shoe Accessory Kit	-	7

DISCONTINUED

CLASS C

PLATFORM TRUCKS



CATALOG PAGE 75

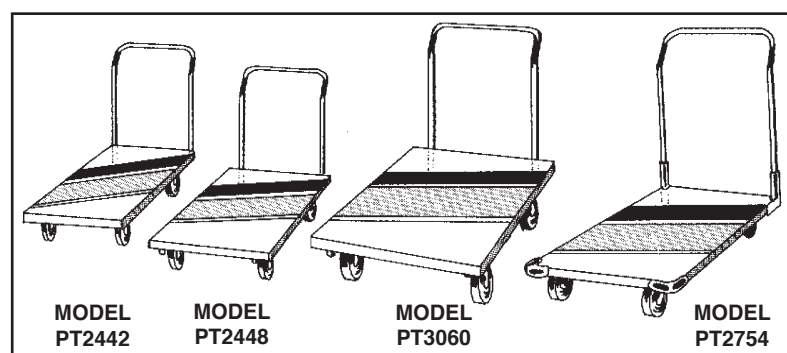

Product Number	Size W" x L"	Description	List Price Ea.	Shpg. Wt.
COMMERCIAL GRADE				
PT 2442	24 x 42	600 Lb. Cap.	250.32	56
INDUSTRIAL GRADE				
PT 2448	24 x 48	1600 Lb. Cap.	315.52	60
PT 2754	27 x 54	1600 Lb. Cap.	341.79	66
PT 3060	30 x 60	2500 Lb. Cap.	494.56	86

CLASS C

COMMERCIAL SERVICE CARTS



CATALOG PAGE 76

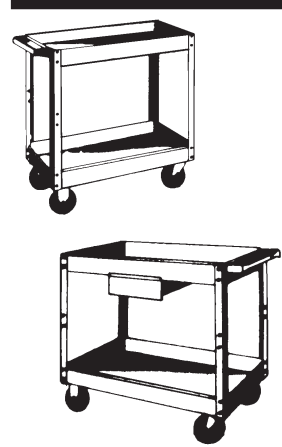

Product Number	Size W" x D" x H"	List Price Ea.	Shpg. Wt.
SC-2020	28 x 20 x 32	150.69	40.0
SC-2024	36 x 24 x 32	174.16	44.0
SC-2016	30 x 16 x 32	147.25	32.0
SC-2120	28 x 20 x 32	186.41	59.0
SC-2124	36 x 24 x 32	209.87	71.0
SC-2116	30 x 16 x 32	182.97	47.0
SC-2224	36 x 24 x 32 w/2 drawers (not shown)	245.56	86.0
OPTIONAL SERVICE CART DRAWER			
WD-1218	12 x 18 x 4	35.70	12.0

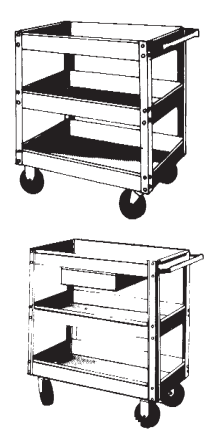

Product Number	Size W" x D" x H"	List Price Ea.	Shpg. Wt.
SC-3020	28 x 20 x 32	183.58	55.0
SC-3024	36 x 24 x 32	218.72	71.5
SC-3016	30 x 16 x 32	176.55	41.5
SC-3120	28 x 20 x 32	219.27	70.0
SC-3124	36 x 24 x 32	254.43	86.5
SC-3116	30 x 16 x 32	212.25	56.5
SC-3224	36 x 24 x 32 w/2 drawers (not shown)	290.14	101.5

**CLASS
C**

INDUSTRIAL SERVICE CARTS



CATALOG PAGE 77



Product Number	Size W" x D" x H"	List Price Ea.	Shpg. Wt.
SC 5000	30 x 16 x 32	176.42	46
SC 6000	36 x 24 x 32	215.36	63



Product Number	Size W" x D" x H"	List Price Ea.	Shpg. Wt.
SC 5003	30" x 16" x 32"	209.77	59
SC 6003	36" x 24" x 32"	265.29	84

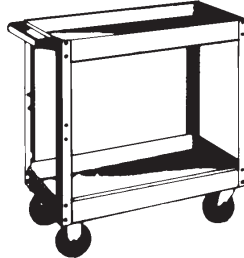

Product Number	Description	Size W" x D" x H"	List Price Ea.	Shpg. Wt.
SC1800	Service Cart, 2 Shelf, 1,000 Lb Capacity	30" x 18" x 36" H	179.94	37.0
SC1800T	Extra Shelf	30" x 18" x 2" H	33.95	12.0
SC1801	Service Cart, 2 Shelf, 1,000 Lb Capacity	36" x 24" x 36" H	219.67	52.0
SC1801T	Extra Shelf	36" x 24" x 2" H	50.90	19.0
SC1802	Service Cart, 2 Shelf, 1,000 Lb Capacity	48" x 18" x 36" H	188.50	54.0
SC1802T	Extra Shelf	48" x 18" x 2" H	45.04	21.0
SC1803	Service Cart, 2 Shelf, 1,000 Lb Capacity	48" x 24" x 36" H	207.90	59.0
SC1803T	Extra Shelf	48" x 24" x 2" H	53.04	22.0

**CLASS
C**

STEEL CARTS & WORK CENTER



CATALOG PAGE 78



Product Number	Size W" x D" x H"	No. of Trays	List Price Ea.	Shpg. Wt.
WSC3018	18" x 30" x 36"	2	244.87	39.0
WSC3624	24" x 36" x 36"	2	263.08	54.0
SCMB20048	28" x 16" x 34"	3	275.29	53.0

**CLASS
C**

STOCK TRUCKS



CATALOG PAGE 79

OPEN SHELF TRUCK



CATALOG PAGE 79

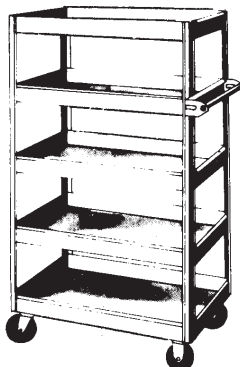

Product Number	Size W" x D" x H"	List Price Ea.	Shpg. Wt.
ST8000	30 x 16 x 60	255.84	78
ST8003	30 x 16 x 60	289.19	91
ST9000	36 x 24 x 60	324.43	107
ST9003	36 x 24 x 60	374.35	128

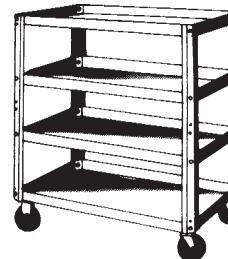

Product Number	Size W" x D" x H"	List Price Ea.	Shpg. Wt.
OT-2436-3	36 x 24 x 42	290.26	60.0
OT-2436-4	36 x 24 x 42	341.10	75.0
OT-2436-5	36 x 24 x 42	391.92	90.0
OT-2043-3	43 x 20 x 42	303.21	62.0
OT-2043-4	43 x 20 x 42	351.09	77.0
OT-2043-5	43 x 20 x 42	399.00	93.0

CLASS C **CLOSED SHELF TRUCK**  **UTILITY TRUCK**  **CATALOG PAGE 79**



Product Number	Size W" x D" x H"	List Price Each Item	Approx. Shpg. Wt.
CT-2436-3	36 x 24 x 42	367.75	91.0
CT-2436-4	36 x 24 x 42	418.58	106.0
CT-2436-5	36 x 24 x 42	469.41	121.0
CT-2043-3	43 x 20 x 42	384.88	93.0
CT-2043-4	43 x 20 x 42	432.79	108.0
CT-2043-5	43 x 20 x 42	480.67	124.0

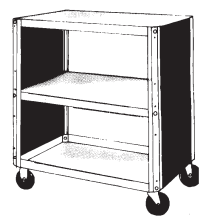

Product Number	Size W" x D" x H"	List Price Each Item	Approx. Shpg. Wt.
UT-2436-3	36 x 24 x 42	367.75	71.0
UT-2436-4	36 x 24 x 42	418.58	86.0
UT-2436-5	36 x 24 x 42	469.41	101.0
UT-2043-3	43 x 20 x 42	384.88	73.0
UT-2043-4	43 x 20 x 42	432.79	88.0
UT-2043-5	43 x 20 x 42	480.67	104.0

CLASS C **TOOL TOTER**  **CATALOG PAGE 80**

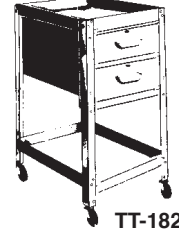

Product Number	Size W" x D" x H"	List Price Each Item	Approx. Shpg. Wt.
TT - 1824-2	18 x 24 x 34 1/2	254.38	55.0
TT - 1824-4	18 x 24 x 34 1/2	377.55	85.0
TT - 1824-C	18 x 24 x 34 1/2	388.21	71.0

CLASS C **MOBILE TOOL CARRIER**  **CATALOG PAGE 80**



DISCONTINUED

4 DRAWER

Product Number	Size W" x D" x H"	List Price Each Item	Approx. Shpg. Wt.
WS 704	20 1/4 x 20 1/4 x 32 1/2	-	88 lbs.

CLASS C **TOOL STANDS**  **CATALOG PAGE 81**

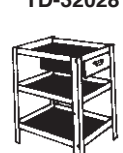
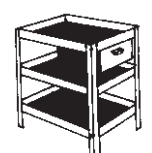

Product Number	Size W" x D" x H"	List Price Each Item	Approx. Shpg. Wt.
T-22028	20 x 28 x 32	114.50	35.0
TC-22028	20 x 28 x 35	153.85	37.5
T-32028	20 x 28 x 32	153.60	47.0
TC-32028	20 x 28 x 35	192.96	49.5
TD-22028	20 x 28 x 32	150.22	49.0
TCD-22028	20 x 28 x 35	189.56	51.5
TD-32028	20 x 28 x 32	189.31	61.0
TCD-32028	20 x 28 x 35	228.64	63.5
T-22436	24 x 36 x 32	125.76	45.0
TC-22436	24 x 36 x 35	165.15	47.5
T-32436	24 x 36 x 32	176.59	60.0
TC-32436	24 x 36 x 35	216.00	62.5
TD-22436	24 x 36 x 32	161.47	59.0
TCD-22436	24 x 36 x 35	200.87	61.5
TD-32436	24 x 36 x 32	212.28	74.0
TCD-32436	24 x 36 x 35	251.68	76.5

**CLASS
C**

WELDED STOCK TRUCKS



CATALOG PAGE 82

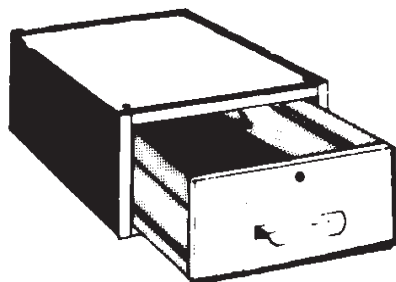
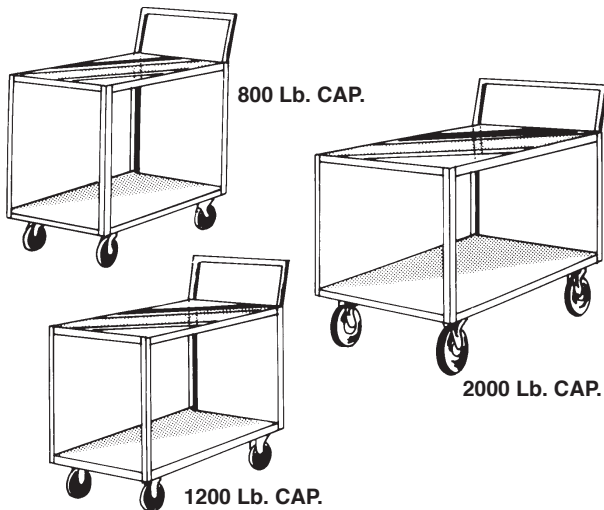

SD2014AMK

800 LB. CAPACITY TRUCKS W/5" POLYPROPYLENE CASTERS

Product Number	Size W" x L" x H"	List Each	Approx. Shpg. Wt.
TW9500	24 x 36 x 30 ¹ / ₄	386.25	88
TW9501	24 x 48 x 30 ¹ / ₄	435.97	98
TW9512	30 x 48 x 30 ¹ / ₄	455.94	92
TW9502	30 x 60 x 30 ¹ / ₄	568.17	134
TW9513	36 x 72 x 30 ¹ / ₄	522.98	160

1200 LB. CAPACITY TRUCKS W/6" POLYPROPYLENE CASTERS

TW9503	24 x 36 x 31 ¹ / ₂	477.48	90
TW9504	24 x 48 x 31 ¹ / ₂	524.61	100
TW9514	30 x 48 x 31 ¹ / ₂	503.53	97
TW9505	30 x 60 x 31 ¹ / ₂	660.42	136
TW9515	36 x 72 x 31 ¹ / ₂	570.56	165

2000 LB. CAPACITY TRUCKS W/8" POLYPROPYLENE CASTERS

TW9506	24 x 36 x 34	575.00	101
TW9507	24 x 48 x 34	621.69	104
TW9516	30 x 48 x 48	566.66	110
TW9508	30 x 60 x 34	762.38	147
TW9517	36 x 72 x 34	633.70	178

1200 LB. CAPACITY TRUCKS W/8" PNEUMATIC CASTERS

TW9509	24" x 36" x 34"	648.91	130.0
TW9510	24" x 48" x 34"	698.11	150.0
TW9518	30" x 48" x 34"	725.10	114.0
TW9511	30" x 60" x 34"	830.82	190.0
TW9519	36" x 72" x 34"	799.03	182.0

OPTIONAL DRAWING

Product Number	Size W" x D" x H"	List Each	Approx. Shpg. Wt.
SD2014AMK	17 ¹ / ₄ "W x 20"D x 6 ¹ / ₂ "H	123.50	15.0

**CLASS
C**

5 SHELF OPEN WELDED TRUCKS



CATALOG PAGE 82



WOS1601

Product No.	Size (L" x W" x H")	Capacity	Caster Type	List Ea.	Weight Ea.
WOS1600	36" x 24" x 64"	800 Lb	5" Polypropylene	347.29	200.0
WOS1601	48" x 24" x 64"	800 Lb	5" Polypropylene	440.07	240.0
WOS1602	48" x 30" x 64"	800 Lb	5" Polypropylene	524.45	280.0
WOS1603	60" x 30" x 64"	800 Lb	5" Polypropylene	613.35	325.0

**CLASS
C**

3 SHELF WELDED INSTRUMENT TRUCKS



CATALOG PAGE 82



WIT731

Product No.	Size (L" x W" x H")	Capacity	Caster Type	List Ea.	Weight Ea.
WIT730	36" x 24" x 55"	1200 Lb	8" Pneumatic	676.14	170.0
WIT731	48" x 24" x 55"	1200 Lb	8" Pneumatic	764.38	195.0
WIT732	60" x 30" x 55"	1200 Lb	8" Pneumatic	809.86	280.0

CLASS C

MODULAR WELDED TRUCKS



CATALOG PAGE 83



Product No.	Size	Capacity	Caster Type	List Ea.	Weight Ea.
MT2501	48" x 24" x 41" H	800 Lb	5" Polypropylene Casters	438.86	125.0
MT2502	48" x 24" x 42" H	1200 Lb	6" Polypropylene Casters	485.64	126.0
MT2503	48" x 24" x 44" H	2000 Lb	8" Polypropylene Casters	546.03	130.0
MT2504	48" x 24" x 45" H	1200 Lb	8" Pneumatic Casters	701.53	130.0

Product No.	Description	Size	List Ea.	Wt. Ea.
MT2505	Cabinet Module	23" W x 22" D x 29½" H	336.51	95.0
MT2506	4 Drawer Module	23" W x 22" D x 29½" H	552.01	150.0



MT2501 w/
MT2505 &
MT2506

CLASS C

PORTABLE STEEL TABLES



CATALOG PAGE 83

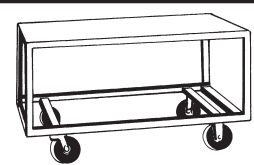

1,200 LB. CAPACITY W/6" POLYPROPYLENE CASTERS

Product #	Size W" x L" x H"	List Ea.	Wt. Ea.
PMD2436	24" x 36" x 31-1/2"	405.02	48.0
PMD2448	24" x 48" x 31-1/2"	425.76	54.0
PMD3048	30" x 48" x 31-1/2"	436.62	57.0
PMD3060	30" x 60" x 31-1/2"	460.51	67.0
PMD3672	36" x 72" x 31-1/2"	485.13	99.0

2,000 LB. CAPACITY W/8" POLYPROPYLENE CASTERS

Product #	Size W" x L" x H"	List Ea.	Wt. Ea.
PSC2436	24" x 36" x 34"	445.14	57.0
PSC2448	24" x 48" x 34"	470.87	64.0
PSC3048	30" x 48" x 34"	496.13	73.0
PSC3060	30" x 60" x 34"	514.08	78.0
PSC3672	36" x 72" x 34"	574.71	98.0

800 LB. CAPACITY W/5" POLYPROPYLENE CASTERS

Product #	Size W" x L" x H"	List Ea.	Wt. Ea.
PCD2436	24" x 36" x 30-1/4"	357.44	43.0
PCD2448	24" x 48" x 30-1/4"	378.20	49.0
PCD3048	30" x 48" x 30-1/4"	388.27	52.0
PCD3060	30" x 60" x 30-1/4"	412.91	62.0
PCD3672	36" x 72" x 30-1/4"	437.56	94.0

1,200 LB. CAPACITY W/8" PNEUMATIC CASTERS

Product #	Size W" x L" x H"	List Ea.	Wt. Ea.
PNE2436	24" x 36" x 34"	626.61	65.0
PNE2448	24" x 48" x 34"	647.36	71.0
PNE3048	30" x 48" x 34"	657.47	74.0
PNE3060	30" x 60" x 34"	682.08	84.0
PNE3672	36" x 72" x 34"	706.74	116.0

BOTTOM TRAYS

Product #	Size W" x L"	List Ea.	Wt. Ea.
PST2436T	24"W x 36"L	57.36	25.0
PST2448T	24"W x 48"L	71.88	33.0
PST3048T	30"W x 48"L	85.05	40.0
PST3060T	30"W x 60"L	102.67	49.0
PST3672T	36"W x 72"L	154.46	66.0

CLASS C

ENCLOSED WELDED TRUCKS



CATALOG PAGE 84

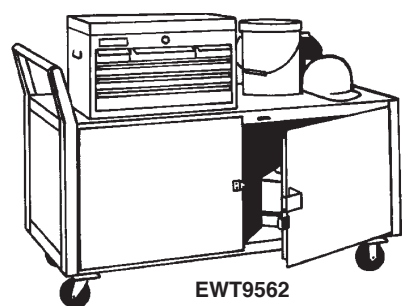

EWT9562

Product No.	Size (L" x W" x H")	Capacity	Caster Type	List Ea.	Weight Ea.
EWT9559	36" x 24" x 30"	800 Lb	5" Polypropylene	500.08	160.0
EWT9560	48" x 24" x 30"	800 Lb	5" Polypropylene	542.16	190.0
EWT9561	48" x 30" x 30"	800 Lb	5" Polypropylene	568.12	210.0
EWT9562	60" x 30" x 30"	800 Lb	5" Polypropylene	650.35	235.0
EWT9563	36" x 24" x 31"	1200 Lb	6" Polypropylene	546.87	165.0
EWT9564	48" x 24" x 31"	1200 Lb	6" Polypropylene	588.95	195.0
EWT9565	48" x 30" x 31"	1200 Lb	6" Polypropylene	614.91	215.0
EWT9566	60" x 30" x 31"	1200 Lb	6" Polypropylene	757.56	240.0
EWT9567	36" x 24" x 33"	2000 Lb	8" Polypropylene	607.29	165.0
EWT9568	48" x 24" x 33"	2000 Lb	8" Polypropylene	649.37	195.0
EWT9569	48" x 30" x 33"	2000 Lb	8" Polypropylene	675.33	215.0
EWT9570	60" x 30" x 33"	2000 Lb	8" Polypropylene	757.56	245.0
EWT9571	36" x 24" x 34"	1200 Lb	8" Pneumatic	762.77	180.0
EWT9572	48" x 24" x 34"	1200 Lb	8" Pneumatic	804.85	210.0
EWT9573	48" x 30" x 34"	1200 Lb	8" Pneumatic	830.82	230.0
EWT9574	60" x 30" x 34"	1200 Lb	8" Pneumatic	913.03	255.0

CLASS C

WELDED INSTRUMENT CARTS



CATALOG PAGE 84

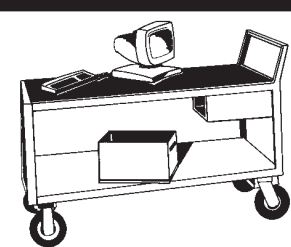

Product #	Size W" x L"	List Ea.	Wt. Ea.
TW9550	24" x 36"	704.26	119
TW9551	24" x 48"	748.90	130
TW9552	30" x 48"	796.78	143
TW9553	30" x 60"	891.63	165
Optional Drawer			
SD2014AMK	17½"W x 20"D x 6½"H	123.50	15

**CLASS
C**

ENCLOSED WELDED INSTRUMENT CARTS



CATALOG PAGE 85

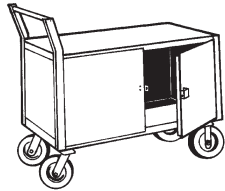

Product No.	Size (L" x W" x H")	Capacity	Caster Type	List Ea.	Weight Ea.
EWT9554	36" x 24" x 34"	1200 Lb	8" Pneumatic	803.42	180.0
EWT9555	48" x 24" x 34"	1200 Lb	8" Pneumatic	848.06	210.0
EWT9557	48" x 30" x 34"	1200 Lb	8" Pneumatic	879.07	230.0
EWT9558	60" x 30" x 34"	1200 Lb	8" Pneumatic	966.36	255.0

**CLASS
C**

DOUBLE ACCESS MOBILE WORK CENTER



CATALOG PAGE 85



DISCONTINUED

Product #	Description	Size (W" x D" x H")	List Ea.	Wt. Ea.
MB400	12 Drawer/12 Bin	36 x 24 D x 37	-	220

**CLASS
C**

MOBILE SERVICE BENCHES



CATALOG PAGE 86

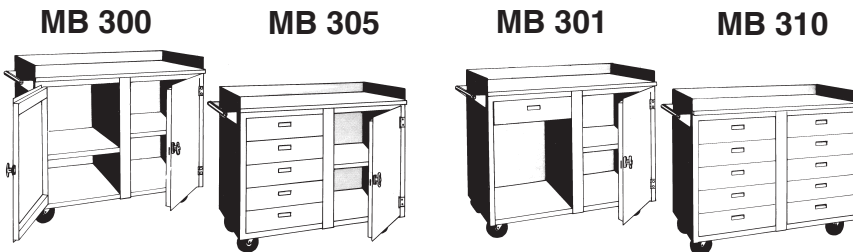

Product #	Description	List Ea.	Wt. Ea.
MB 300	2 Door	712.61	130
MB 301	1 Drawer/1 Door	728.57	135
MB 304	4 Drawer/1 Door	1,024.19	168
MB 305	5 Drawer/1 Door	1,127.84	174
MB308	8 Drawer	1,326.02	209
MB 310	10 Drawer	1,543.08	218
CL 3	Cylinder Lock*	12.95	—

*Available in 5 different key combinations. Consult factory.

**CLASS
C**

Premier
BY EDRAL

MOBILE MAINTENANCE BENCHES



CATALOG PAGE 87

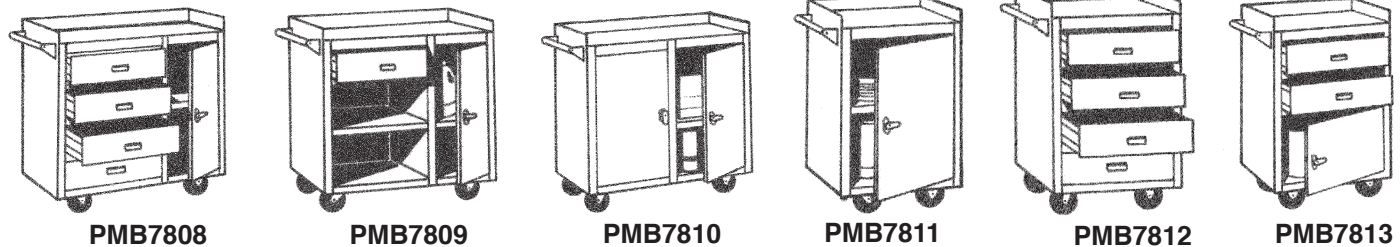

Product #	Description	Size (W" x D" x H")	List Ea.	Wt. Ea.
PMB7808	4 Drawer/1 Door	36" W x 22" D x 34"	913.22	210.0
PMB7809	1 Drawer/1 Door	36" W x 22" D x 34"	761.01	160.0
PMB7810	2 Door	36" W x 22" D x 34"	599.01	175.0
PMB7811	1 Door	23" W x 22" D x 34"	472.08	110.0
PMB7812	4 Drawer	23" W x 22" D x 34"	602.99	160.0
PMB7813	2 Drawer/1 Door	23" W x 22" D x 34"	577.60	125.0
PMB7814	1 Drawer/1 Door	45" W x 22" D x 34"	828.31	205.0
PMB7815	8 Drawer	45" W x 22" D x 34"	1,258.56	270.0
PMB7816	4 Drawer/1 Door	45" W x 22" D x 34"	1,023.93	230.0

CLASS C MOBILE SERVICE BENCHES



CATALOG PAGE 88

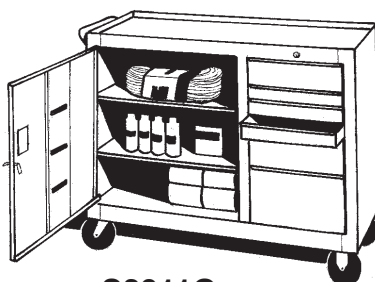

S3911G

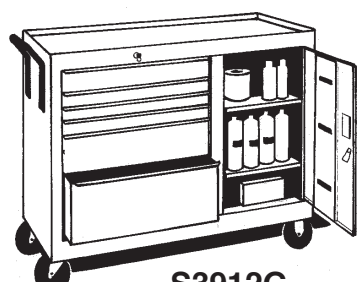

S3912G

Product Number	Description	List Price	Shpg. Wt.
S3911G	Wide Door 6 Narrow Drawers	1,120.16	131
S3912G	6 Wide Drawers Narrow Door	1,145.28	138

CLASS C MOBILE MAINTENANCE BENCHES



CATALOG PAGE 89

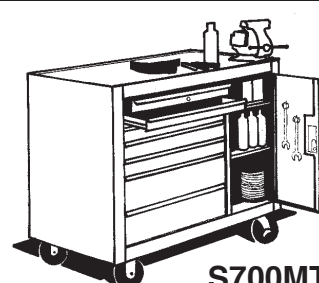

S700MTC



DISCONTINUED

S701MTC



DISCONTINUED

S702MTC

Product Number	Description	List Price	Shpg. Wt.
S700MTC	7 Drawers in Front/Cabinet in Front	2,967.53	393
S701MTC	12 Drawers in Front/Cabinet on Side	-	341
S702MTC	Side Rider	-	64

CLASS C ECONOMY WORK BENCHES



CATALOG PAGE 91

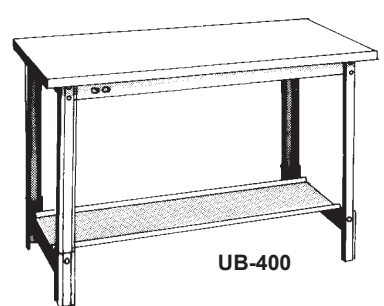

UB-400

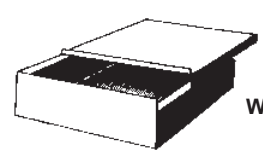

WD-1218

Product #	Top Style	Size (W" x D")	List Ea.	Shpg. Wt.
UB-400	Flakeboard	48 x 24	136.15	70
UB-500	Flakeboard	60 x 24	167.67	76
UB-600	Flakeboard	72 x 24	204.74	82
UB-700	Flakeboard	60 x 30	228.54	83
UB-800	Flakeboard	72 x 30	254.57	92
LWB-2448	Plastic Laminate	48 x 24	233.19	77
LWB-2460	Plastic Laminate	60 x 24	283.23	83
LWB-3072	Plastic Laminate	72 x 30	376.85	122
UBM-4830	Masonite/Flakeboard	48 x 30	175.95	73
UBM-6030	Masonite/Flakeboard	60 x 30	250.55	85
UBM-7230	Masonite/Flakeboard	72 x 30	279.04	95

ECONOMY LINE ACCESSORIES

Product #	Description	Size (W" x D" x H")	List Ea.	Shpg. Wt.
WD-1218	Economy Drawer	12 x 18 x 4	35.70	12

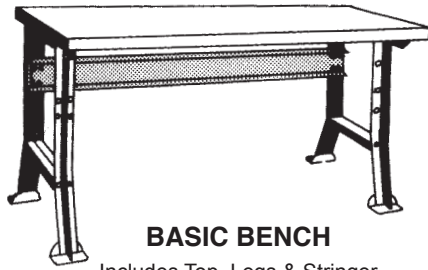

BASIC BENCH

Includes Top, Legs & Stringer

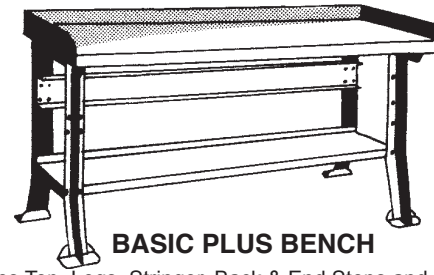

BASIC PLUS BENCH

Includes Top, Legs, Stringer, Back & End Stops and Lower Shelf

STEEL TOP

Product Number		Size W" x D"	Ht.	List Price Each Item	Approx. Shpg. Wt.
Gray	Tan				
5301	5301T	48 x 30	34"	248.61	101.0
5302	5302T	48 x 36	34"	267.74	112.0
5303	5303T	60 x 30	34"	266.94	110.0
5304	5304T	60 x 36	34"	309.74	132.0
5305	5305T	72 x 30	34"	305.45	126.0
5306	5306T	72 x 36	34"	341.50	147.0
5301-30	5301-30T	48 x 30	30"	247.45	99.0
5302-30	5302-30T	48 x 36	30"	267.74	110.0
5303-30	5303-30T	60 x 30	30"	265.77	108.0
5304-30	5304-30T	60 x 36	30"	309.74	130.0
5305-30	5305-30T	72 x 30	30"	304.29	124.0
5306-30	5306-30T	72 x 36	30"	341.50	145.0

Product Number		Size W" x D"	Ht.	List Price Each Item	Approx. Shpg. Wt.
Gray	Tan				
5307	5307T	48 x 30	34"	353.64	119.0
5308	5308T	48 x 36	34"	376.44	130.0
5309	5309T	60 x 30	34"	384.18	132.0
5310	5310T	60 x 36	34"	430.77	158.0
5311	5311T	72 x 30	34"	441.14	153.0
5312	5312T	72 x 36	34"	480.85	174.0
5307-30	5307-30T	48 x 30	30"	352.46	117.0
5308-30	5308-30T	48 x 36	30"	376.44	128.0
5309-30	5309-30T	60 x 30	30"	382.99	130.0
5310-30	5310-30T	60 x 36	30"	430.77	156.0
5311-30	5311-30T	72 x 30	30"	439.96	151.0
5312-30	5312-30T	72 x 36	30"	480.85	172.0

TEMPERED PRESSED WOOD ON STEEL

PW-5301	PW-5301T	48 x 30	34"	292.45	115.0
PW-5302	PW-5302T	48 x 36	34"	317.99	130.0
PW-5303	PW-5303T	60 x 30	34"	333.95	128.0
PW-5304	PW-5304T	60 x 36	34"	393.47	146.0
PW-5305	PW-5305T	72 x 30	34"	392.17	144.0
PW-5306	PW-5306T	72 x 36	34"	435.62	166.0
PW-5301-30	PW-5301-30T	48 x 30	30"	291.26	113.0
PW-5302-30	PW-5302-30T	48 x 36	30"	317.99	128.0
PW-5303-30	PW-5303-30T	60 x 30	30"	332.78	126.0
PW-5304-30	PW-5304-30T	60 x 36	30"	393.47	144.0
PW-5305-30	PW-5305-30T	72 x 30	30"	391.00	142.0
PW-5306-30	PW-5306-30T	72 x 36	30"	435.62	164.0

PW-5307	PW-5307T	48 x 30	34"	397.46	133.0
PW-5308	PW-5308T	48 x 36	34"	426.69	148.0
PW-5309	PW-5309T	60 x 30	34"	451.16	150.0
PW-5310	PW-5310T	60 x 36	34"	514.48	168.0
PW-5311	PW-5311T	72 x 30	34"	527.84	171.0
PW-5312	PW-5312T	72 x 36	34"	574.96	193.0
PW-5307-30	PW-5307-30T	48 x 30	30"	396.28	131.0
PW-5308-30	PW-5308-30T	48 x 36	30"	426.69	146.0
PW-5309-30	PW-5309-30T	60 x 30	30"	449.99	148.0
PW-5310-30	PW-5310-30T	60 x 36	30"	514.48	166.0
PW-5311-30	PW-5311-30T	72 x 30	30"	526.68	169.0
PW-5312-30	PW-5312-30T	72 x 36	30"	574.96	191.0

SHOP TOP

Product Number		Size W" x D"	Ht.	List Price Each Item	Approx. Shpg. Wt.
Gray	Tan				
W5325	W5325T	60 x 30	34	357.92	162
W5326	W5326T	72 x 30	34	400.45	181
W5327	W5327T	72 x 36	34	449.73	208
W5325-30	W5325-30T	60 x 30	30	356.77	159
W5326-30	W5326-30T	72 x 30	30	399.30	178
W5327-30	W5327-30T	72 x 36	30	449.73	205

Product Number		Size W" x D"	Ht.	List Price Each Item	Approx. Shpg. Wt.
Gray	Tan				
W5334	W5334T	60 x 30	34	475.12	196
W5335	W5335T	72 x 30	34	536.11	221
W5336	W5336T	72 x 36	34	589.08	248
W5334-30	W5334-30T	60 x 30	30	473.99	193
W5335-30	W5335-30T	72 x 30	30	534.98	218
W5336-30	W5336-30T	72 x 36	30	585.40	245

PLASTIC LAMINATE

L5328	L5328T	60 x 30	34	387.73	165
L5329	L5329T	72 x 30	34	432.76	185
L5330	L5330T	72 x 36	34	496.25	212
L5328-30	L5328-30T	60 x 30	30	386.59	162
L5329-30	L5329-30T	72 x 30	30	431.61	182
L5330-30	L5330-30T	72 x 36	30	496.25	209

L5337	L5337T	60 x 30	34	504.94	199
L5338	L5338T	72 x 30	34	568.43	225
L5339	L5339T	72 x 36	34	635.59	252
L5337-30	L5337-30T	60 x 30	30	503.79	196
L5338-30	L5338-30T	72 x 30	30	567.28	222
L5339-30	L5339-30T	72 x 36	30	631.91	249

BUTCHER BLOCK MAPLE

M5331	M5331T	60 x 30	34	496.44	181
M5332	M5332T	72 x 30	34	578.69	180
M5333	M5333T	72 x 36	34	668.45	208
M5331-30	M5331-30T	60 x 30	30	495.31	178
M5332-30	M5332-30T	72 x 30	30	577.55	177
M5333-30	M5333-30T	72 x 36	30	668.45	205

M5340	M5340T	60 x 30	34	613.64	195
M5341	M5341T	72 x 30	34	714.37	220
M5342	M5342T	72 x 36	34	807.79	248
M5340-30	M5340-30T	60 x 30	30	612.50	192
M5341-30	M5341-30T	72 x 30	30	713.23	217
M5342-30	M5342-30T	72 x 36	30	804.12	245

Standard color is Industrial Gray. For Beige add "T" suffix to the model number.

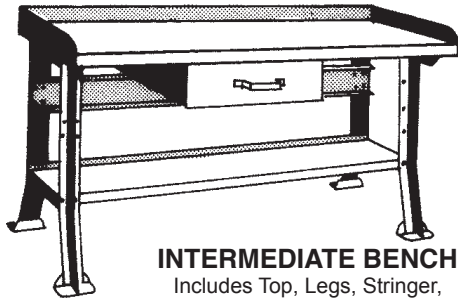

INTERMEDIATE BENCH
Includes Top, Legs, Stringer,
Back & End Stops, Drawer and Lower Shelf

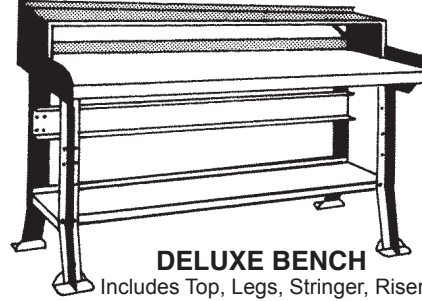

DELUXE BENCH
Includes Top, Legs, Stringer, Riser,
Back & End Stops and Lower Shelf

STEEL TOP

Product Number		Size W" x D"	Ht.	List Price Each Item	Approx. Shpg. Wt.
Gray	Tan				
5313	5313T	48 x 30	34"	439.46	134.0
5314	5314T	48 x 36	34"	462.26	145.0
5315	5315T	60 x 30	34"	469.99	147.0
5316	5316T	60 x 36	34"	516.60	173.0
5317	5317T	72 x 30	34"	526.97	168.0
5318	5318T	72 x 36	34"	566.69	189.0
5313-30	5313-30T	48 x 30	30"	438.29	132.0
5314-30	5314-30T	48 x 36	30"	462.26	143.0
5315-30	5315-30T	60 x 30	30"	468.81	145.0
5316-30	5316-30T	60 x 36	30"	516.60	171.0
5317-30	5317-30T	72 x 30	30"	525.78	166.0
5318-30	5318-30T	72 x 36	30"	566.69	187.0

Product Number		Size W" x D"	Ht.	List Price Each Item	Approx. Shpg. Wt.
Gray	Tan				
5319	5319T	48 x 30	34"	433.07	150.0
5320	5320T	48 x 36	34"	455.86	161.0
5321	5321T	60 x 30	34"	471.37	165.0
5322	5322T	60 x 36	34"	517.97	191.0
5323	5323T	72 x 30	34"	550.24	189.0
5324	5324T	72 x 36	34"	589.95	210.0
5319-30	5319-30T	48 x 30	30"	431.89	148.0
5320-30	5320-30T	48 x 36	30"	455.86	159.0
5321-30	5321-30T	60 x 30	30"	470.19	163.0
5322-30	5322-30T	60 x 36	30"	517.97	189.0
5323-30	5323-30T	72 x 30	30"	549.07	187.0
5324-30	5324-30T	72 x 36	30"	589.95	208.0

TEMPERED PRESSED WOOD ON STEEL

PW-5313	PW-5313T	48 x 30	34"	483.28	148.0
PW-5314	PW-5314T	48 x 36	34"	512.53	163.0
PW-5315	PW-5315T	60 x 30	34"	536.99	165.0
PW-5316	PW-5316T	60 x 36	34"	600.31	173.0
PW-5317	PW-5317T	72 x 30	34"	613.67	188.0
PW-5318	PW-5318T	72 x 36	34"	660.80	208.0
PW-5313-30	PW-5313-30T	48 x 30	30"	482.11	146.0
PW-5314-30	PW-5314-30T	48 x 36	30"	512.53	161.0
PW-5315-30	PW-5315-30T	60 x 30	30"	535.82	163.0
PW-5316-30	PW-5316-30T	60 x 36	30"	600.31	171.0
PW-5317-30	PW-5317-30T	72 x 30	30"	612.51	184.0
PW-5318-30	PW-5318-30T	72 x 36	30"	660.80	206.0

PW-5319	PW-5319T	48 x 30	34"	476.88	164.0
PW-5320	PW-5320T	48 x 36	34"	506.13	179.0
PW-5321	PW-5321T	60 x 30	34"	538.38	183.0
PW-5322	PW-5322T	60 x 36	34"	601.70	191.0
PW-5323	PW-5323T	72 x 30	34"	636.95	203.0
PW-5324	PW-5324T	72 x 36	34"	684.06	235.0
PW-5319-30	PW-5319-30T	48 x 30	30"	475.71	162.0
PW-5320-30	PW-5320-30T	48 x 36	30"	506.13	177.0
PW-5321-30	PW-5321-30T	60 x 30	30"	537.21	181.0
PW-5322-30	PW-5322-30T	60 x 36	30"	601.70	189.0
PW-5323-30	PW-5323-30T	72 x 30	30"	635.77	201.0
PW-5324-30	PW-5324-30T	72 x 36	30"	684.06	233.0

SHOP TOP

Product Number		Size W" x D"	Ht.	List Price Each Item	Approx. Shpg. Wt.
Gray	Tan				
W5343	W5343T	60 x 30	34	560.96	218
W5344	W5344T	72 x 30	34	621.94	243
W5345	W5345T	72 x 36	34	674.90	270
W5343-30	W5343-30T	60 x 30	30	559.80	215
W5344-30	W5344-30T	72 x 30	30	620.81	240
W5345-30	W5345-30T	72 x 36	30	666.46	267

Product Number		Size W" x D"	Ht.	List Price Each Item	Approx. Shpg. Wt.
Gray	Tan				
W5353	W5353T	60 x 30	34	562.33	214
W5354	W5354T	72 x 30	34	645.22	242
W5355	W5355T	72 x 36	34	698.16	269
W5353-30	W5353-30T	60 x 30	30	561.19	211
W5354-30	W5354-30T	72 x 30	30	644.06	239
W5355-30	W5355-30T	72 x 36	30	698.16	266

PLASTIC LAMINATE

L5347	L5347T	60 x 30	34	590.77	221
L5348	L5348T	72 x 30	34	654.26	247
L5349	L5349T	72 x 36	34	721.42	274
L5347-30	L5347-30T	60 x 30	30	589.62	218
L5348-30	L5348-30T	72 x 30	30	653.11	244
L5349-30	L5349-30T	72 x 36	30	717.75	271

L5356	L5356T	60 x 30	34	592.16	217
L5357	L5357T	72 x 30	34	677.52	246
L5358	L5358T	72 x 36	34	744.68	273
L5356-30	L5356-30T	60 x 30	30	591.00	214
L5357-30	L5357-30T	72 x 30	30	676.38	243
L5358-30	L5358-30T	72 x 36	30	741.01	270

BUTCHER BLOCK MAPLE

M5350	M5350T	60 x 30	34	699.47	217
M5351	M5351T	72 x 30	34	800.20	242
M5352	M5352T	72 x 36	34	893.62	270
M5350-30	M5350-30T	60 x 30	30	698.33	214
M5351-30	M5351-30T	72 x 30	30	799.05	239
M5352-30	M5352-30T	72 x 36	30	889.95	267

M5359	M5359T	60 x 30	34	700.86	213
M5360	M5360T	72 x 30	34	823.46	241
M5361	M5361T	72 x 36	34	916.90	269
M5359-30	M5359-30T	60 x 30	30	699.72	210
M5360-30	M5360-30T	72 x 30	30	822.32	238
M5361-30	M5361-30T	72 x 36	30	913.22	266

Standard color is Industrial Gray. For Beige add "T" suffix to the model number.

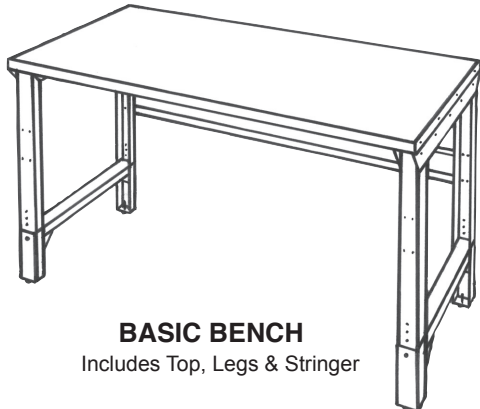

BASIC BENCH
Includes Top, Legs & Stringer



BASIC PLUS BENCH
Includes Top, Legs, Stringer,
Back & End Stops and Lower Shelf

STEEL TOP

Product Number		Size W" x D"	Ht.	List Price Each Item	Approx. Shpg. Wt.
Gray	Tan				
1018S	1018ST	48 x 30	30"-34"	265.00	93
1019S	1019ST	48 x 36	30"-34"	286.37	107
1000S	1000ST	60 x 30	30"-34"	283.34	103
1020S	1020ST	60 x 36	30"-34"	328.39	124
1001S	1001ST	72 x 30	30"-34"	321.85	118
1002S	1002ST	72 x 36	30"-34"	360.14	128

Product Number		Size W" x D"	Ht.	List Price Each Item	Approx. Shpg. Wt.
Gray	Tan				
1118S	1118ST	48 x 30	30"-34"	370.03	121
1119S	1119ST	48 x 36	30"-34"	395.08	136
1100S	1100ST	60 x 30	30"-34"	400.57	142
1120S	1120ST	60 x 36	30"-34"	449.40	159
1101S	1101ST	72 x 30	30"-34"	457.54	163
1102S	1102ST	72 x 36	30"-34"	499.49	175

PRESSED WOOD OVER STEEL

1021PW	1021PWT	48 x 30	30"-34"	308.83	104
1022PW	1022PWT	48 x 36	30"-34"	336.65	120
1012PW	1012PWT	60 x 30	30"-34"	350.36	115
1023PW	1023PWT	60 x 36	30"-34"	412.12	138
1013PW	1013PWT	72 x 30	30"-34"	408.57	130
1014PW	1014PWT	72 x 36	30"-34"	454.27	155

1121PW	1121PWT	48 x 30	30"-34"	413.85	132
1122PW	1122PWT	48 x 36	30"-34"	445.33	149
1112PW	1112PWT	60 x 30	30"-34"	467.55	154
1123PW	1123PWT	60 x 36	30"-34"	533.12	173
1113PW	1113PWT	72 x 30	30"-34"	544.25	175
1114PW	1114PWT	72 x 36	30"-34"	593.61	202

SHOP TOP

1003W	1003WT	60 x 30	30"-34"	374.33	102
1004W	1004WT	72 x 30	30"-34"	416.84	138
1005W	1005WT	72 x 36	30"-34"	468.34	162

1103W	1103WT	60 x 30	30"-34"	491.51	168
1104W	1104WT	72 x 30	30"-34"	552.52	193
1105W	1105WT	72 x 36	30"-34"	607.68	219

PLASTIC LAMINATE

1006L	1006LT	60 x 30	30"-34"	404.13	124
1007L	1007LT	72 x 30	30"-34"	449.16	142
1008L	1008LT	72 x 36	30"-34"	514.85	166

1106L	1106LT	60 x 30	30"-34"	521.33	171
1107L	1107LT	72 x 30	30"-34"	584.83	197
1108L	1108LT	72 x 36	30"-34"	654.19	223

BUTCHER BLOCK MAPLE

1009M	1009MT	60 x 30	30"-34"	512.83	120
1010M	1010MT	72 x 30	30"-34"	595.09	137
1011M	1011MT	72 x 36	30"-34"	687.06	162

1109M	1109MT	60 x 30	30"-34"	630.04	167
1110M	1110MT	72 x 30	30"-34"	730.76	192
1111M	1111MT	72 x 36	30"-34"	826.40	219

Standard color is Industrial Gray. For Beige add "T" suffix to the model number.

Includes Top,
Legs, Stringer,
Back & End
Stops, Riser &
Lower Shelf

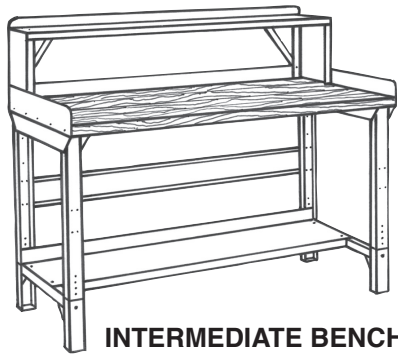

INTERMEDIATE BENCH

Includes Top,
Legs, Stringer,
Riser, Back
& End Stops,
Drawer and
Lower Shelf

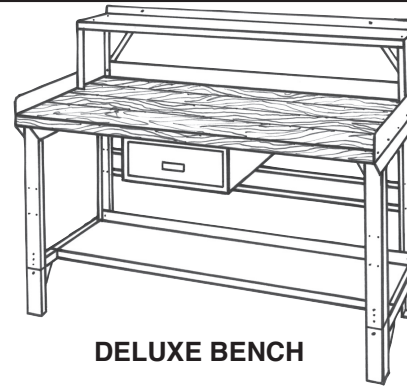

DELUXE BENCH

STEEL TOP

Product Number		Size		List Price Each Item	Approx. Shpg. Wt.
Gray	Tan	W" x D"	Ht.		
1318S	1318ST	48 x 30	30"-34"	449.46	137
1319S	1319ST	48 x 36	30"-34"	474.50	150
1300S	1300ST	60 x 30	30"-34"	487.75	160
1320S	1320ST	60 x 36	30"-34"	536.62	171
1301S	1301ST	72 x 30	30"-34"	566.63	184
1302S	1302ST	72 x 36	30"-34"	608.58	196

Product Number		Size		List Price Each Item	Approx. Shpg. Wt.
Gray	Tan	W" x D"	Ht.		
1418S	1418ST	48 x 30	30"-34"	562.59	152
1419S	1419ST	48 x 36	30"-34"	587.62	167
1400S	1400ST	60 x 30	30"-34"	600.90	175
1420S	1420ST	60 x 36	30"-34"	649.74	192
1401S	1401ST	72 x 30	30"-34"	679.76	199
1402S	1402ST	72 x 36	30"-34"	721.71	211

PRESSED WOOD OVER STEEL

1321PW	1321PWT	48 x 30	30"-34"	493.28	148
1322PW	1322PWT	48 x 36	30"-34"	524.76	165
1312PW	1312PWT	60 x 30	30"-34"	554.76	172
1323PW	1323PWT	60 x 36	30"-34"	620.33	191
1313PW	1313PWT	72 x 30	30"-34"	653.35	196
1314PW	1314PWT	72 x 36	30"-34"	702.72	223

1421PW	1421PWT	48 x 30	30"-34"	606.41	163
1422PW	1422PWT	48 x 36	30"-34"	637.89	180
1412PW	1412PWT	60 x 30	30"-34"	667.90	187
1423PW	1423PWT	60 x 36	30"-34"	733.46	206
1413PW	1413PWT	72 x 30	30"-34"	766.47	211
1414PW	1414PWT	72 x 36	30"-34"	815.85	238

SHOP TOP

1303W	1303WT	60 x 30	30"-34"	578.72	184
1304W	1304WT	72 x 30	30"-34"	639.72	211
1305W	1305WT	72 x 36	30"-34"	716.78	240

1403W	1403WT	60 x 30	30"-34"	691.85	199
1404W	1404WT	72 x 30	30"-34"	774.73	226
1405W	1405WT	72 x 36	30"-34"	829.90	255

PLASTIC LAMINATE

1306L	1306LT	60 x 30	30"-34"	600.77	187
1307L	1307LT	72 x 30	30"-34"	672.04	215
1308L	1308LT	72 x 36	30"-34"	763.29	244

1406L	1406LT	60 x 30	30"-34"	713.90	202
1407L	1407LT	72 x 30	30"-34"	785.17	230
1408L	1408LT	72 x 36	30"-34"	876.42	259

BUTCHER BLOCK MAPLE

1309M	1309MT	60 x 30	30"-34"	709.47	183
1310M	1310MT	72 x 30	30"-34"	839.85	210
1311M	1311MT	72 x 36	30"-34"	935.50	240

1409M	1409MT	60 x 30	30"-34"	830.38	198
1410M	1410MT	72 x 30	30"-34"	952.98	225
1411M	1411MT	72 x 36	30"-34"	1,048.62	255

Standard color is Industrial Gray. For Beige add "T" suffix to the model number.

Includes Top, Legs & Stringer

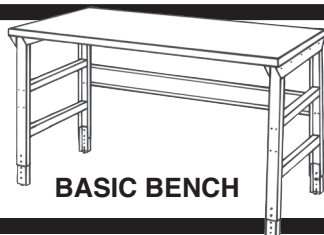

BASIC BENCH

Includes Top, Legs, Stringer, Back & End Stops and Lower Shelf

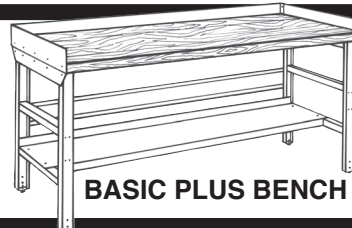

BASIC PLUS BENCH

STEEL TOP

Product Number		Size W" x D"	Ht.	List Price Each Item	Approx. Shpg. Wt.
Blue	Tan				
BMS6030B	BMS6030T	60 x 30	30"-34"	336.69	120
BMS7230B	BMS7230T	72 x 30	30"-34"	383.02	137
BMS7236B	BMS7236T	72 x 36	30"-34"	424.66	150

Product Number		Size W" x D"	Ht.	List Price Each Item	Approx. Shpg. Wt.
Blue	Tan				
PMS6030B	PMS6030T	60 x 30	30"-34"	453.89	154
PMS7230B	PMS7230T	72 x 30	30"-34"	518.70	177
PMS7236B	PMS7236T	72 x 36	30"-34"	564.02	191

BUTCHER BLOCK MAPLE

BMM6030B	BMM6030T	60 x 30	30"-34"	533.68	137
BMM7230B	BMM7230T	72 x 30	30"-34"	615.94	156
BMM7236B	BMM7236T	72 x 36	30"-34"	709.81	184

PMM6030B	PMM6030T	60 x 30	30"-34"	650.87	171
PMM7230B	PMM7230T	72 x 30	30"-34"	751.61	196
PMM7236B	PMM7236T	72 x 36	30"-34"	849.16	225

SHOP TOP

BMT6030B	BMT6030T	60 x 30	30"-34"	395.17	138
BMT7230B	BMT7230T	72 x 30	30"-34"	437.67	157
BMT7236B	BMT7236T	72 x 36	30"-34"	491.09	184

PMT6030B	PMT6030T	60 x 30	30"-34"	512.37	172
PMT7230B	PMT7230T	72 x 30	30"-34"	573.35	197
PMT7236B	PMT7236T	72 x 36	30"-34"	630.45	225

PLASTIC LAMINATE

BML6030B	BML6030T	60 x 30	30"-34"	424.96	141
BML7230B	BML7230T	72 x 30	30"-34"	470.01	161
BML7236B	BML7236T	72 x 36	30"-34"	537.62	188

PML6030B	PML6030T	60 x 30	30"-34"	542.16	175
PML7230B	PML7230T	72 x 30	30"-34"	605.66	201
PML7236B	PML7236T	72 x 36	30"-34"	676.96	229

Includes Top, Legs, Stringer, Back & End Stops, Drawer and Lower Shelf

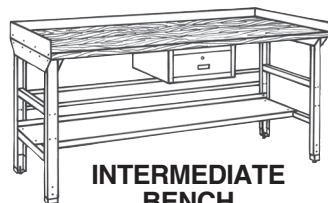

INTERMEDIATE BENCH

Includes Top, Legs, Stringer, Riser, Back & End Stops, Drawer & Lower Shelf

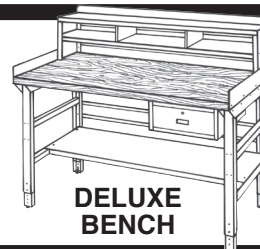

DELUXE BENCH

STEEL TOP

Product Number		Size W" x D"	Ht.	List Price Each Item	Approx. Shpg. Wt.
Blue	Tan				
IMS6030B	IMS6030T	60 x 30	30"-34"	583.99	174
IMS7230B	IMS7230T	72 x 30	30"-34"	648.78	197
IMS7236B	IMS7236T	72 x 36	30"-34"	694.10	211

Product Number		Size W" x D"	Ht.	List Price Each Item	Approx. Shpg. Wt.
Blue	Tan				
DMS6030B	DMS6030T	60 x 30	30"-34"	699.10	210
DMS7230B	DMS7230T	72 x 30	30"-34"	770.55	239
DMS7236B	DMS7236T	72 x 36	30"-34"	815.86	253

BUTCHER BLOCK MAPLE

IMM6030B	IMM6030T	60 x 30	30"-34"	780.97	191
IMM7230B	IMM7230T	72 x 30	30"-34"	881.69	216
IMM7236B	IMM7236T	72 x 36	30"-34"	979.24	245

DMM6030B	DMM6030T	60 x 30	30"-34"	896.10	227
DMM7230B	DMM7230T	72 x 30	30"-34"	1,003.45	258
DMM7236B	DMM7236T	72 x 36	30"-34"	1,101.01	287

SHOP TOP

IMT6030B	IMT6030T	60 x 30	30"-34"	642.44	192
IMT7230B	IMT7230T	72 x 30	30"-34"	703.44	217
IMT7236B	IMT7236T	72 x 36	30"-34"	760.52	245

DMT6030B	DMT6030T	60 x 30	30"-34"	757.59	228
DMT7230B	DMT7230T	72 x 30	30"-34"	825.20	259
DMT7236B	DMT7236T	72 x 36	30"-34"	882.29	287

PLASTIC LAMINATE

IML6030B	IML6030T	60 x 30	30"-34"	672.26	195
IML7230B	IML7230T	72 x 30	30"-34"	735.75	221
IML7236B	IML7236T	72 x 36	30"-34"	807.05	249

DML6030B	DML6030T	60 x 30	30"-34"	787.38	231
DML7230B	DML7230T	72 x 30	30"-34"	857.51	263
DML7236B	DML7236T	72 x 36	30"-34"	928.80	291

When ordering, please specify Blue or Beige. Add suffix (B) Blue or (T) Beige to the model number.

CLASS C

96" WIDE 3-LEG WORK BENCHES

WITH BUTCHER BLOCK MAPLE & SHOP TOPS



CATALOG PAGE 98

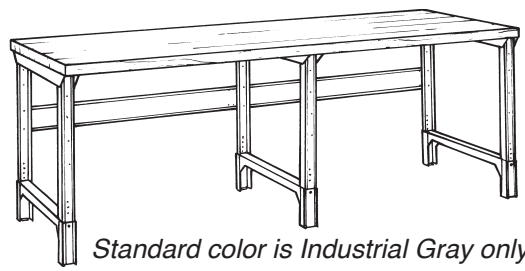

Standard color is Industrial Gray only.

Model No.	Description	Size WxDxHt	Description	List Each	Wt Ea.
6310MT	Flared Leg	96" x 30" x 34"	Butcher Block Maple Top	751.77	172.0
6311MT	Flared Leg	96" x 36" x 34"	Butcher Block Maple Top	857.08	190.0
6315ST	Flared Leg	96" x 30" x 33 3/4"	Shop Top	471.58	172.0
6316ST	Flared Leg	96" x 36" x 33 3/4"	Shop Top	544.49	190.0
6318PT	Flared Leg	96" x 30" x 34"	Plastic Laminate Top	493.45	233.0
6319PT	Flared Leg	96" x 36" x 34"	Plastic Laminate Top	570.60	236.0
6332S	Flared Leg	96" x 30" x 34"	Steel Top	477.27	175.0
6320MT	Adjustable Ht Leg	96" x 30" x 30 3/4" - 34 3/4"	Butcher Block Maple Top	776.37	170.0
6321MT	Adjustable Ht Leg	96" x 36" x 30 3/4" - 34 3/4"	Butcher Block Maple Top	885.00	188.0
6325ST	Adjustable Ht Leg	96" x 30" x 30 1/2" - 34 1/2"	Shop Top	496.17	170.0
6326ST	Adjustable Ht Leg	96" x 36" x 30 1/2" - 34 1/2"	Shop Top	572.41	188.0
6328PT	Adjustable Ht Leg	96" x 30" x 30 3/4" - 34 3/4"	Plastic Laminate Top	518.04	241.0
6329PT	Adjustable Ht Leg	96" x 36" x 30 3/4" - 34 3/4"	Plastic Laminate Top	598.51	250.0
6334S	Adjustable Ht Leg	96" x 30" x 30 3/4" - 34 3/4"	Steel Top	501.87	183.0

CLASS C

WORK BENCH ACCESSORIES



CATALOG PAGES 99 & 100

BACK & END STOPS

Product #		Size W" x H"	List Price Each Item	Approx. Shpg. Wt.
Gray	Beige			
5501	5501T	48x30	48.83	10.0
5502	5502T	48x36	52.52	11.0
5503	5503T	60x30	50.36	12.0
5504	5504T	60x36	54.17	13.0
5505	5505T	72x30	58.17	13.0
5506	5506T	72x36	61.84	14.0
5507	5507T	96x30	59.81	15.0
5508	5508T	96x36	62.76	16.0



BACK & END STOPS

ABOVE THE TOP



BENCH RISER

PREMIER BACK & END STOPS

Product #		Size W" x D"	List Price Each Item	Approx. Shpg. Wt.
Blue	Beige			
PBE3509B	PBE3509T	60" x 30"	50.36	12.0
PBE3510B	PBE3510T	72" x 30"	58.17	13.0
PBE3511B	PBE3511T	72" x 36"	61.84	14.0



PREMIER DUAL RISER

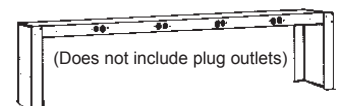

ELECTRONIC RISER

BENCH RISERS

Product #		Size W" x D"	List Price Each Item	Approx. Shpg. Wt.
Gray	Beige			
5409	5409T	48" x 10 1/2" x 12"	79.44	16.0
5410	5410T	60" x 10 1/2" x 12"	87.21	18.0
5411	5411T	72" x 10 1/2" x 12"	109.10	21.0

PREMIER DUAL RISERS

Product #		Size W" x D"	List Price Each Item	Approx. Shpg. Wt.
Blue	Beige			
PR3505B	PR3505T	60" x 10 1/2" x 12"	115.14	36.0
PR3506B	PR3506T	72" x 10 1/2" x 12"	121.76	42.0

ELECTRONIC RISERS & ACCESSORIES

Product #	Size W" x D" x H"	List Price Each Item	Approx. Shpg. Wt.
Gray			
E-704	60" x 15" x 18"	187.68	37.0
E-702	72" x 15" x 18"	223.44	41.0
E-703	96" x 15" x 18"	270.31	51.0
EADP-6	Power Center Mount	117.15	16.0
* & Lower Shelf Kit - 35"W (Does not include plug outlets)			
EW-1	Optional Power Center*	111.78	2.0
*(4 duplex plug outlets, lighted switch, circuit breaker & 8' cord only)			

BELOW THE TOP

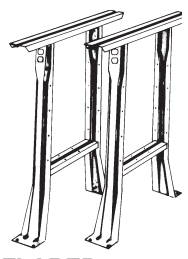

FLARED BENCH LEGS

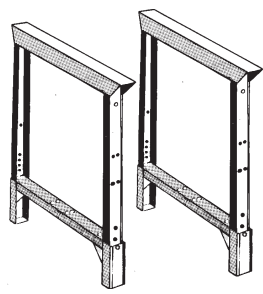

ADJUSTABLE BENCH LEGS



PREMIER BENCH LEGS



BENCH STRINGER

FLARED BENCH LEGS

Product #		Size D" x H"	List Price Each Item	Approx. Shpg. Wt.
Gray	Beige			
5707	5707T	30" x 28"	43.25	13.5
5708	5708T	36" x 28"	47.48	15.0
5709	5709T	30" x 32 1/4"	43.84	16.5
5710	5710T	36" x 32 1/4"	47.48	18.0

ADJUSTABLE BENCH LEGS

Product #		Size D"	List Price Each Item	Approx. Shpg. Wt.
Gray	Beige			
ABL 30	ABL 30T	30"	52.02	19.0
ABL 36	ABL 36T	36"	56.78	21.0

PREMIER BENCH LEGS

Product #		Size D"	List Price Each Item	Approx. Shpg. Wt.
Blue	Beige			
PL3503B	PL3503T	30"	62.45	21.0
PL3504B	PL3504T	36"	68.16	24.0

BENCH STRINGER

Product #		Size W" x H"	List Price Each Item	Approx. Shpg. Wt.
Gray	Beige			
ST-48	ST-48T	48" x 6"	18.27	6.5
ST-60	ST-60T	60" x 6"	23.57	8.0
ST-72	ST-72T	72" x 6"	29.45	10.0

PREMIER BENCH STRINGER

Product #		Size W" x H"	List Price Each Item	Approx. Shpg. Wt.
Blue	Beige			
PS3513B	PS3513T	60" x 6"	23.57	8.0
PS3514B	PS3514T	72" x 6"	29.45	10.0

**CLASS
C**

WORK BENCH ACCESSORIES



CATALOG PAGES 99 & 100

**BELOW
THE TOP**

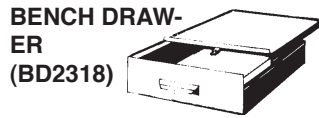

**BENCH DRAWER
(BD2318)**

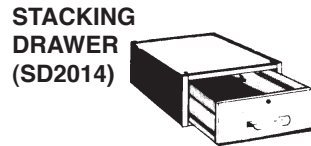

**STACKING DRAWER
(SD2014)**



**PREMIER STACKING DRAWER
(PSD3512)**



CL-10 CYLINDER LOCK

LOWER SHELF				
Product Number		Size	List Price	Approx.
Gray	Beige	W" x D"	Each Item	Shpg. Wt.
5601	5601T	48"x 15"	56.20	18.0
5602	5602T	60"x 15"	66.83	22.0
5603	5603T	72"x 15"	77.52	27.0

PREMIER LOWER SHELF				
Product Number		Size	List Price	Approx.
Blue	Beige	D" x H"	Each Item	Shpg. Wt.
PS3507B	PS3507T	60"x 15"	66.83	22.0
PS3508B	PS3508T	72"x 15"	77.52	27.0

BENCH DRAWERS/LOCKS				
Product Number		Size	List Price	Approx.
Gray	Beige	D" x H"	Each Item	Shpg. Wt.
BD2318	BD2318T	Bench-18 ¹ / ₄ x 23 ⁷ / ₈ x 5 ³ / ₈	85.83	22.0
SD2014	SD2014T	Stacking-17 ¹ / ₄ x 20 x 6 ¹ / ₂	113.13	15.0
CL10	—	Cylinder Lock	12.83	0.5

PREMIER BENCH DRAWERS				
Product Number		Size	List Price	Approx.
Blue	Beige	D" x H"	Each Item	Shpg. Wt.
PSD3512B	PSD3512T	Stacking-17 ¹ / ₄ x 20 x 6 ¹ / ₂	130.08	20.0
CL10	—	Cylinder Lock	12.83	0.5

**CLASS
C**

WORK BENCH TOPS



CATALOG PAGE 101

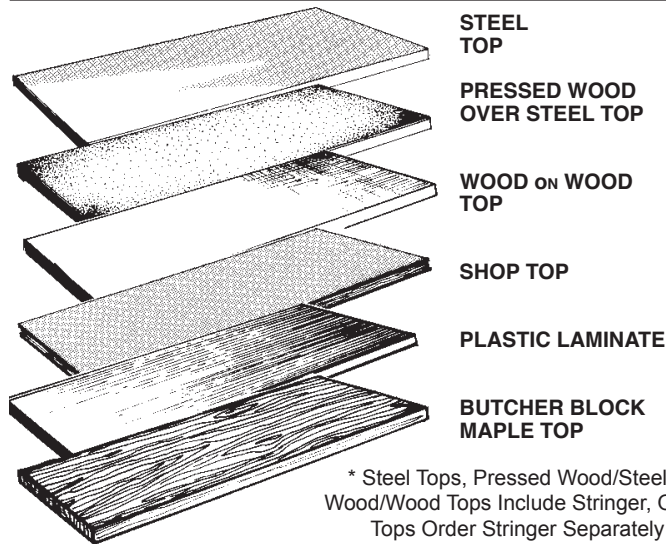

* Steel Tops, Pressed Wood/Steel & Wood/Wood Tops Include Stringer, Other Tops Order Stringer Separately

STEEL TOPS				
Product Number		Size	List Price	Approx.
Gray	Beige	W" x D"	Each Item	Shpg. Wt.
5301TA	5301TAT	48"x30"	160.93	55.0
5302TA	5302TAT	48"x36"	172.79	65.0
5303TA	5303TAT	60"x30"	179.28	70.0
5304TA	5304TAT	60"x36"	214.81	82.0
5305TA	5305TAT	72"x30"	217.80	85.0
5306TA	5306TAT	72"x36"	246.57	92.0
5308TA	5308TAT	96"x30"	309.24	113.0

PREMIER STEEL TOPS				
Product Number		Size	List Price	Approx.
Blue	Beige	W" x D"	Each Item	Shpg. Wt.
PTA3500B	PTA3500T	60" x 30"	188.23	70
PTA3501B	PTA3501T	72"x 30"	228.69	85
PTA3502B	PTA3502T	72"x 36"	258.91	92

PRESSED WOOD OVER STEEL TOPS				
Product Number		Size	List Price	Approx.
Gray	Beige	W" x D"	Each Item	Shpg. Wt.
PW5301TA	PW5301TAT	48"x 30"	204.76	66.0
PW5302TA	PW5302TAT	48"x36"	223.05	78.0
PW5303TA	PW5303TAT	60"x30"	246.27	82.0
PW5304TA	PW5304TAT	60"x36"	298.53	96.0
PW5305TA	PW5305TAT	72"x30"	304.49	97.0
PW5306TA	PW5306TAT	72"x36"	340.68	119.0

PLASTIC LAMINATE			
Product #	Size W" x D"	List Ea.	Shpg. Wt.
GLT3060	60"x30"	276.50	91.0
GLT3072	72"x30"	315.66	109.0
GLT3672	72"x36"	371.85	130.0
GLT3096	96"x30"	325.42	171.0
GLT3696	96"x36"	391.63	174.0

BUTCHER BLOCK MAPLE			
Product #	Size W" x D"	List Ea.	Shpg. Wt.
BB3060	60"x30"	385.22	87.0
BB3072	72"x30"	461.58	104.0
BB3672	72"x36"	544.04	126.0
BB3096	96"x30"	583.74	153.0
BB3696	96"x36"	678.12	168.0

ANTI-STATIC TOPS			
Product #	Size W" x D"	List Ea.	Shpg. Wt.
GOAS3060	60"x30"	341.43	90.0
GOAS3072	72"x30"	407.00	105.0
GOAS3672	72"x36"	479.49	130.0

SHOP TOP			
Product #	Size W" x D"	List Ea.	Shpg. Wt.
ST3060	60"x30"	246.70	88.0
ST3072	72"x30"	283.34	105.0
ST3672	72"x36"	325.32	126.0
ST3096	96"x30"	303.54	140.0
ST3696	96"x36"	365.54	167.0

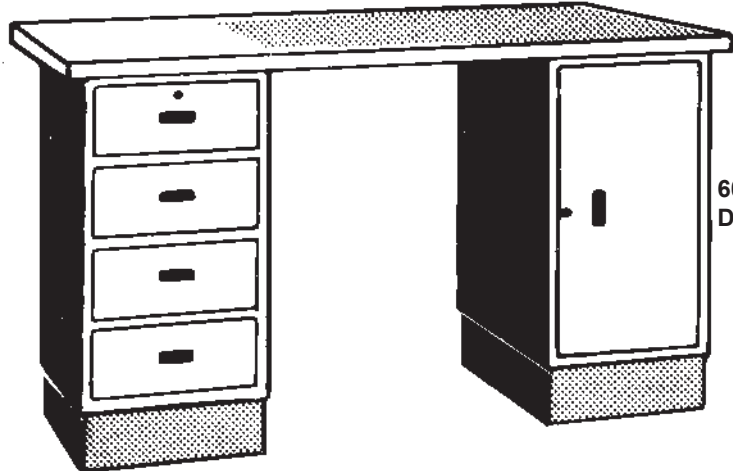

**600 SERIES
DRAWER/CABINET**

Product Number	Size Top W" x D"	List Price	Approx. Shpg. Wt.
600-60-S	60 x 30	1,012.19	181 lbs.
600-72-S	72 x 30	1,050.71	196 lbs.
600-60-W	60 x 30	1,061.31	199 lbs.
600-72-W	72 x 30	1,097.95	216 lbs.

Product Number	Size Top W" x D"	List Price	Approx. Shpg. Wt.
600-60-L	60 x 30	1,091.12	202 lbs.
600-72-L	72 x 30	1,130.26	220 lbs.
600-60-M	60 x 30	1,199.83	198 lbs.
600-72-M	72 x 30	1,276.20	215 lbs.

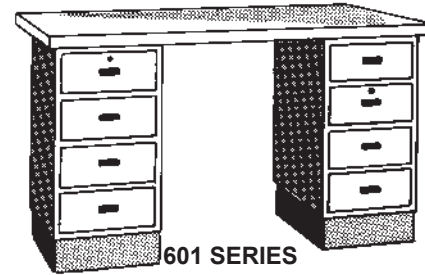

**601 SERIES
DOUBLE DRAWER**

Product Number	Size Top W" x D"	List Price	Approx. Shpg. Wt.
601-60-S	60 x 30	1,269.76	216 lbs.
601-72-S	72 x 30	1,308.29	231 lbs.
601-60-W	60 x 30	1,318.88	234 lbs.
601-72-W	72 x 30	1,355.52	251 lbs.
601-60-L	60 x 30	1,348.68	237 lbs.
601-72-L	72 x 30	1,387.83	255 lbs.
601-60-M	60 x 30	1,457.40	233 lbs.
601-72-M	72 x 30	1,533.77	250 lbs.

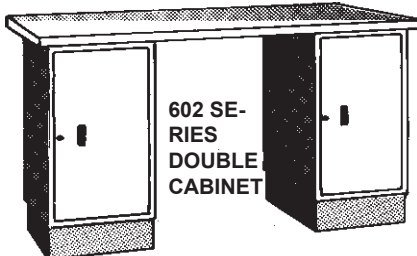

**602 SE-
RIES
DOUBLE
CABINET**

Product Number	Size Top W" x D"	List Price	Approx. Shpg. Wt.
602-60-S	60 x 30	754.62	146 lbs.
602-72-S	72 x 30	793.15	161 lbs.
602-60-W	60 x 30	803.74	164 lbs.
602-72-W	72 x 30	840.37	181 lbs.
602-60-L	60 x 30	833.54	167 lbs.
602-72-L	72 x 30	872.70	185 lbs.
602-60-M	60 x 30	942.25	163 lbs.
602-72-M	72 x 30	1,018.63	180 lbs.

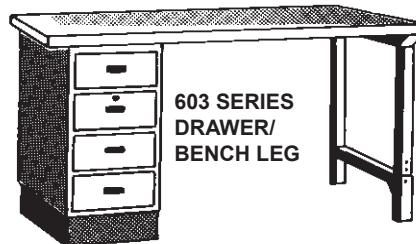

**603 SERIES
DRAWER/
BENCH LEG**

Product Number	Size Top W" x D"	List Price	Approx. Shpg. Wt.
603-60-S	60 x 30	828.57	162 lbs.
603-72-S	72 x 30	867.08	177 lbs.
603-60-W	60 x 30	886.84	180 lbs.
603-72-W	72 x 30	923.47	197 lbs.
603-60-L	60 x 30	916.65	183 lbs.
603-72-L	72 x 30	955.79	201 lbs.
603-60-M	60 x 30	1,025.37	179 lbs.
603-72-M	72 x 30	1,101.72	196 lbs.

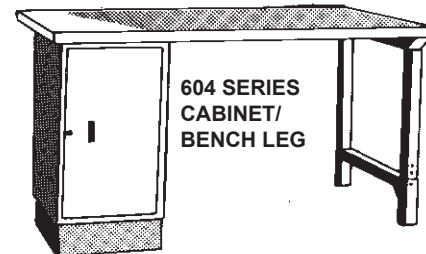

**604 SERIES
CABINET/
BENCH LEG**

Product Number	Size Top W" x D"	List Price	Approx. Shpg. Wt.
604-60-S	60 x 30	571.00	127 lbs.
604-72-S	72 x 30	609.51	142 lbs.
604-60-W	60 x 30	629.26	145 lbs.
604-72-W	72 x 30	665.90	162 lbs.
604-60-L	60 x 30	659.08	148 lbs.
604-72-L	72 x 30	698.21	166 lbs.
604-60-M	60 x 30	767.80	144 lbs.
604-72-M	72 x 30	844.16	161 lbs.

INDIVIDUAL COMPONENTS

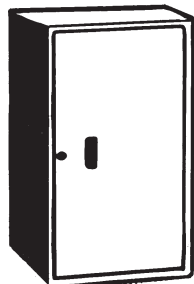

**MODEL 605
CABINET
PEDESTAL**



**MODEL 606
FOUR DRAWER
PEDESTAL**



**MODEL 609
THREE DRAWER
PEDESTAL**

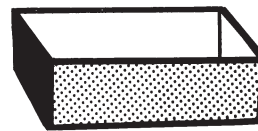

MODEL 607 BASE



**CL-10
CYLINDER
LOCK**

INDIVIDUAL COMPONENTS

Product Number	Description	List Price	Shpg. Wt. (Lbs.)
605	Cabinet Pedestal	233.06	32
606	4-Drawer Pedestal	490.64	67
607	Base	45.46	6
608	Mount Kit for Pedestal w/30"D Steel top	4.59	2
609	3-Drawer Pedestal	512.35	65
CL10	Cylinder Lock	12.83	0.5

**CLASS
C**

MODULAR ELECTRONIC WORK STATIONS



CATALOG PAGE 104

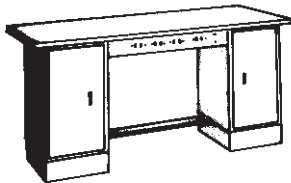

E-7217/E-7220

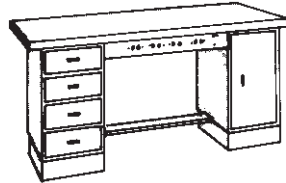

E-7216/E-7219

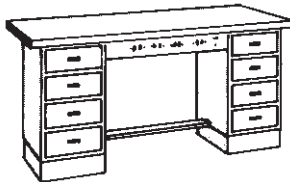

E-7218/E-7221



ELECTRONIC RISER

Product Number	Description	List Price	Shpg. Wt. (Lbs.)
----------------	-------------	------------	------------------

Plastic Laminate Top Work Station - 72" W x 30" D

E-7216	Basic Bench incl. (1) 4 drawer pedestal, (1) cabinet pedestal, (2) bases	1,124.71	194
E-7217	Basic Bench incl. (2) cabinet pedestals, (2) bases	989.84	159
E-7218	Basic Bench incl. (2) 4 drawer pedestals, (2) bases	1,504.97	229

Butcher Block Maple Top Work Station - 72" W x 30" D

E-7219	Basic Bench incl. (1) 4 drawer pedestal, (1) cabinet pedestal, (2) bases	1,393.35	227
E-7220	Basic Bench incl. (2) cabinet pedestals, (2) bases	1,135.78	192
E-7221	Basic Bench incl. (2) 4 drawer pedestals, (2) bases	1,650.92	262

Accessories

E-704	Optional Electronic Riser - 60"W x 15" D x 18"H (Does not include plug outlets)	187.68	37
E-702	Optional Electronic Riser - 72"W x 15"D x 18"H (Does not include plug outlets)	223.44	41
E-703	Optional Electronic Riser - 96"W x 15"D x 18"H (Does not include plug outlets)	270.31	51
EADP-6	Power Center Mount & Lower Shelf Kit 35"W (Does not include plug outlets)	117.15	16
EW-1	Optional Power Center 4 duplex plug outlets, lighted switch, circuit breaker & 8' cord only	111.78	2

**CLASS
C**

ELECTRONIC WORK STATIONS



CATALOG PAGE 105

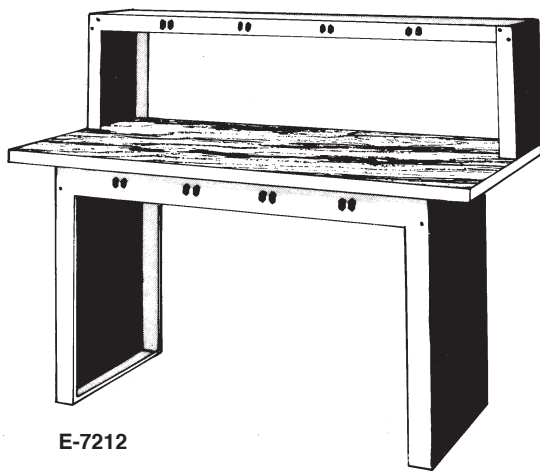

E-7212

Plastic Laminate Top Work Station

Product Number	Top Size W" x D"	Description	List Price Each	Approx. Shp. Wt.
E-7200	72 x 36	Basic Bench-34"H	578.60	155 lbs.
E-7201	96 x 36	Basic Bench-34"H	768.92	193 lbs.
E-7202	72 x 36	Basic Plus Bench with Drawer	664.44	177 lbs.
E-7203	96 x 36	Basic Plus Bench with Drawer	854.76	215 lbs.
E-7204	72 x 36	Intermediate Bench w/18"H Electronic Riser	802.03	196 lbs.
E-7205	96 x 36	Intermediate Bench w/18"H Electronic Riser	1,039.23	234 lbs.
E-7206	72 x 36	Deluxe Bench w/Electronic Riser, and Drawer	887.86	218 lbs.
E-7207	96 x 36	Deluxe Bench w/Electronic Riser, and Drawer	1,125.06	256 lbs.

Butcher Block Maple Top Work Station

Product Number	Top Size W" x D"	Description	List Price Each	Approx. Shp. Wt.
E-7208	72 x 36	Basic Bench-34"H	854.69	195 lbs.
E-7209	96 x 36	Basic Bench-34"H	1,054.16	246 lbs.
E-7210	72 x 36	Basic Plus Bench with Drawer	940.52	217 lbs.
E-7211	96 x 36	Basic Plus Bench with Drawer	1,140.00	268 lbs.
E-7212	72 x 36	Intermediate Bench w/18"H Electronic Riser	1,078.13	264 lbs.
E-7213	96 x 36	Intermediate Bench w/18"H Electronic Riser	1,324.50	324 lbs.
E-7214	72 x 36	Deluxe Bench w/Electronic Riser, and Drawer	1,163.96	346 lbs.
E-7215	72 x 36	Deluxe Bench w/Electronic Riser, and Drawer	1,410.33	346 lbs.

Product Number	Description	List Price Each	Weight Ea. (Lbs.)
EW-1	Power Center*	111.78	2

*(4 duplex plug outlets, lighted switch, circuit breaker & 8' cord only)

**CLASS
C**

PREMIER ELECTRONIC WORKSTATIONS



CATALOG PAGE 106

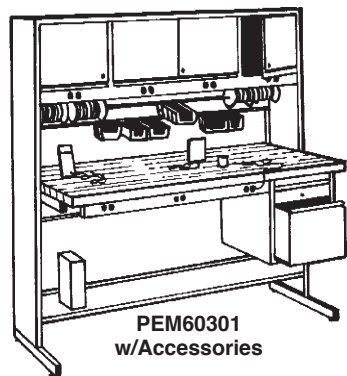

PEM60301
w/Accessories

PREMIER ELECTRONIC WORKSTATIONS				
Product #	Description	Size W"xD"	List Ea.	Shpg. Wt.
PEM60301	Maple Top	60"x30"	993.86	215.0
PEP60304	Non-Conductive Plastic Top	60"x30"	885.14	215.0
PEA60307	Anti-Static Top	60"x30"	950.06	215.0

ELECTRONIC BENCH ACCESSORIES				
Product #	Description	Size W"xD"xH"	List Ea.	Shpg. Wt.
ES1401P	2 Drawer Pedestal, Putty	15"x17"x19"	289.67	35.0
ES1402P	3 Drawer Pedestal, Putty	15"x17"x19"	275.80	38.0
ES1403	Wire Reel Holder for 60"W Bench	60"W	28.95	5.0
ES1409	Wire Reel Holder for 72"W Bench	72"W	34.75	8.0
ES1404	Under Bench Electrical Strip	40"W	34.95	8.0
EW-1	Power Center Kit	-	111.78	2.0

**CLASS
C**

ELECTRONIC WORKCENTERS



CATALOG PAGE 106 & 107

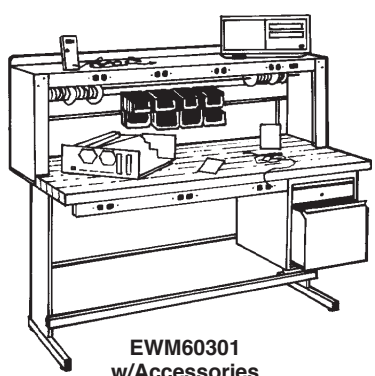

EWM60301
w/Accessories

ELECTRONIC WORKCENTERS				
Product #	Description	Size W"xD"xH"	List Ea.	Shpg. Wt.
EWM60301	Maple Top	60"x30"	693.13	130.0
EWM72302	Maple Top	72"x30"	803.75	150.0
EWM72363	Maple Top	72"x36"	886.22	178.0
EWP60304	Non-Conductive Plastic Top	60"x30"	584.42	130.0
EWP72305	Non-Conductive Plastic Top	72"x30"	657.81	150.0
EWP72366	Non-Conductive Plastic Top	72"x36"	714.00	178.0
EWA60307	Anti-Static Top	60"x30"	649.36	130.0
EWA72308	Anti-Static Top	72"x30"	749.17	150.0
EWA72369	Anti-Static Top	72"x36"	821.66	178.0
ES1407	Riser with Bin Rail	60"x15"x18"	195.69	45.0
ES1408	Riser with Bin Rail	72"x15"x18"	232.98	50.0

ELECTRONIC BENCH ACCESSORIES				
Product #	Description	Size W"xD"xH"	List Ea.	Shpg. Wt.
ES1401P	2 Drawer Pedestal, Putty	15"x17"x19"	289.67	35.0
ES1402P	3 Drawer Pedestal, Putty	15"x17"x19"	275.80	38.0
ES1403	Wire Reel Holder for 60"W Bench	60"W	28.95	5.0
ES1409	Wire Reel Holder for 72"W Bench	72"W	34.75	8.0
ES1404	Under Bench Electrical Strip	40"W	34.95	8.0
EW-1	Power Center Kit	-	111.78	2.0

**CLASS
C**

ELECTRONIC TECH BENCHES



CATALOG PAGE 106 & 107

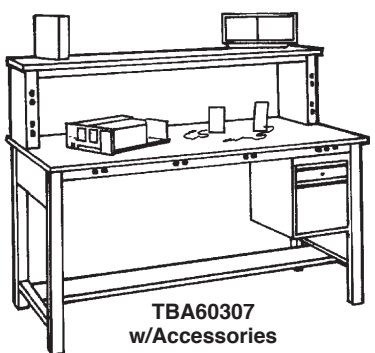

TBA60307
w/Accessories

ELECTRONIC TECH BENCHES				
Product #	Description	Size W"xD"xH"	List Ea.	Shpg. Wt.
TBP60304	Non-Conductive Plastic Top	60"x30"x34"	536.36	165.0
TBP72305	Non-Conductive Plastic Top	72"x30"x34"	606.05	189.0
TBP72366	Non-Conductive Plastic Top	72"x36"x34"	683.69	212.0
TBA60307	Anti-Static Top	60"x30"x34"	601.28	165.0
TBA72308	Anti-Static Top	72"x30"x34"	697.41	189.0
TBA72369	Anti-Static Top	72"x36"x34"	791.33	212.0
TB1273	Riser w/Non-Conductive Plastic Top	60"x15"x18"	347.44	80.0
TB1274	Riser w/Non-Conductive Plastic Top	72"x15"x18"	400.96	96.0
TB1275	Riser with Anti-Static Top	60"x15"x18"	514.64	80.0
TB1276	Riser with Anti-Static Top	72"x15"x18"	589.38	96.0

ELECTRONIC BENCH ACCESSORIES				
Product #	Description	Size W"xD"xH"	List Ea.	Shpg. Wt.
ES1401P	2 Drawer Pedestal, Putty	15"x17"x19"	289.67	35.0
ES1402P	3 Drawer Pedestal, Putty	15"x17"x19"	275.80	38.0
EW-1	Power Center Kit	-	111.78	2.0

**CLASS
C**

PRODUCTION BENCHES



CATALOG PAGE 108

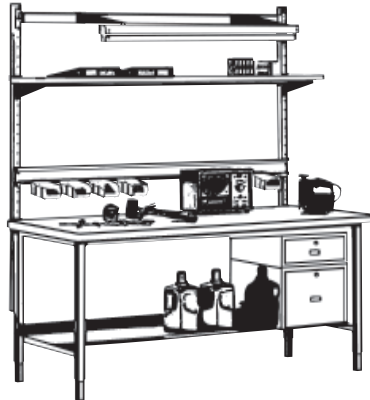

Product Number	Description	Size (W x D)	List Price Ea.	Approx. Shpg. Wt.
B444	Maple Top Bench Complete With Accessories	30" x 60"	1,281.39	281
B445	Maple Top Bench Complete With Accessories	30" x 72"	1,430.06	315
B446	Maple Top Bench Complete With Accessories	30" x 96"	1,646.82	392
B447	Plastic Top Bench Complete With Accessories	30" x 60"	1,062.26	285
B448	Plastic Top Bench Complete With Accessories	30" x 72"	1,174.30	320
B449	Plastic Top Bench Complete With Accessories	30" x 96"	1,316.04	410
B438	Basic Maple Top Bench Only	30" x 60"	706.64	122
B439	Basic Maple Top Bench Only	30" x 72"	806.42	143
B440	Basic Maple Top Bench Only	30" x 96"	956.47	199
B441	Basic Plastic Top Bench Only	30" x 60"	487.50	126
B442	Basic Plastic Top Bench Only	30" x 72"	550.65	148
B443	Basic Plastic Top Bench Only	30" x 96"	625.67	217
B420	Bench Only (No Top)	30" x 60"	321.41	35
B421	Bench Only (No Top)	30" x 72"	344.82	39
B422	Bench Only (No Top)	30" x 96"	372.72	46
B423	Plastic Top Upright Shelf	60"	98.54	34
B424	Plastic Top Upright Shelf	72"	113.09	40
B425	Plastic Top Upright Shelf	96"	131.68	47
B426	Upright Kit		61.65	20
B427	Small Stacking Drawer	6"	92.39	22
B428	Large Stacking Drawer	12"	128.99	30
B429	Bin Rail	60"	38.99	11
B430	Bin Rail	72"	44.98	12
B431	Bin Rail	96"	53.39	15
B432	Light Assembly	60"	89.09	19
B433	Light Assembly	72"	94.94	21
B434	Light Assembly	96"	104.83	24
B435	Lower Shelf	60"	65.10	23
B436	Lower Shelf	72"	87.60	27
B437	Lower Shelf	96"	117.43	35

**CLASS
C**

PACK BENCH COMPONENTS



CATALOG PAGE 109

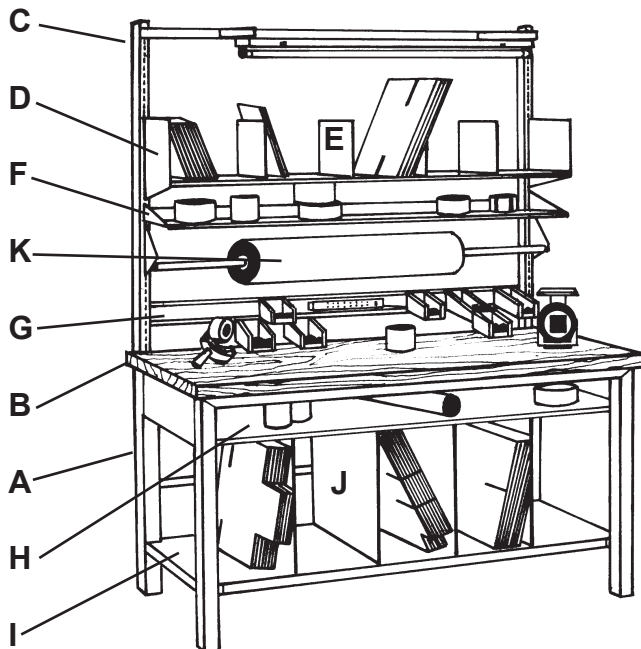

Product Number	Description	List Price	Shpg. Wt. (Lbs.)
TB1230	Complete Bench/Maple Top 60x30	1,902.61	325.0
TB1231	Complete Bench/Maple Top 72x30	2,047.83	375.0
TB1232	Complete Bench/Plastic Top 60x30	1,793.91	329.0
TB1233	Complete Bench/Plastic Top 72x30	1,901.90	380.0

Product #	Key	Description	List Ea.	Shpg. Wt.
TB1280	A	Basic Leg Assembly 60x30	332.02	74.0
TB1281	A	Basic Leg Assembly 72x30	342.01	80.0
GLT3060	B	Grey Laminated Top 60x30	276.50	91.0
GLT3072	B	Grey Laminated Top 72x30	315.66	109.0
BB3060	B	Maple Top 60x30	385.22	87.0
BB3072	B	Maple Top 72x30	461.58	104.0
TB-TF60	C	Overhead Frame 60"	231.71	45.0
TB-TF72	C	Overhead Frame 72"	237.28	50.0
TB-TDS60	D	Overhead Carton Shelf 60"	151.09	28.0
TB-TDS72	D	Overhead Carton Shelf 72"	163.86	35.0
TB-TDK	E	Overhead Shelf Dividers (4)	103.63	8.0
TB-TCS60	F	Overhead Catalog Shelf 60"	102.71	16.0
TB-TCS72	F	Overhead Catalog Shelf 72"	108.25	19.0
TB-TBR60	G	Overhead Bin Rail 60"	61.07	4.0
TB-TBR72	G	Overhead Bin Rail 72"	64.88	6.0
TB-UTS60	H	Underbench Tissue Shelf 60"	182.40	20.0
TB-UTS72	H	Underbench Tissue Shelf 72"	193.34	23.0
TB-UDS60	I	Underbench Carton Shelf 60"	147.58	19.0
TB-UDS72	I	Underbench Carton Shelf 72"	166.65	22.0
TB-UDK	J	Underbench Shelf Dividers (4)	113.07	12.0
TB-UPD60	K	Overhead Paper Dispenser 60"	92.14	12.0
TB-UPD72	K	Overhead Paper Dispenser 72"	93.26	16.0

**CLASS
C**

WORK BENCH CABINETS



CATALOG PAGE 110

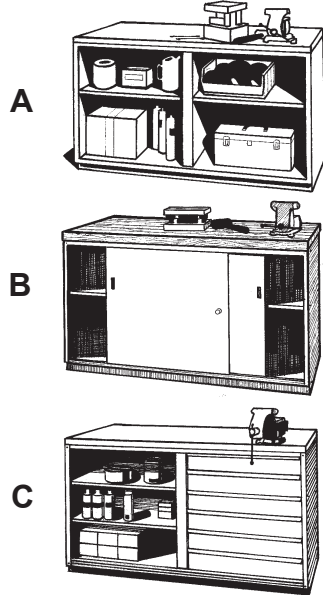

Product Number	Key	Size Description	List Price (WxD)	Each	Approx. Shp. Wt.
CBS2006T	A	Steel Top Work Bench Cabinet	60" x 30"	618.98	225
CBS2007T	A	Steel Top Work Bench Cabinet	72" x 30"	715.11	260
CBM2008T	A	Maple Top Work Bench Cabinet	60" x 30"	824.92	242
CBM2009T	A	Maple Top Work Bench Cabinet	72" x 30"	958.92	279
CBL2010T	A	Plastic Top Work Bench Cabinet	60" x 30"	716.22	246
CBL2011T	A	Plastic Top Work Bench Cabinet	72" x 30"	812.98	284
CBT2012T	A	Shop Top Work Bench Cabinet	60" x 30"	686.41	243
CBT2013T	A	Shop Top Work Bench Cabinet	72" x 30"	780.67	280
CBD2002T	B	Sliding Door Kit (pair)	for 60" wide bench	221.90 pair	35
CBD2003T	B	Sliding Door Kit (pair)	for 72" wide bench	230.64 pair	42
CBI2004T	C	Drawer Insert (6 drawers)	for 60" wide bench	462.47 set	112
CBI2005T	C	Drawer Insert (6 drawers)	for 72" wide bench	508.21 set	129
CB2000T	-	Work Bench Cabinet less top	60" x 30"	439.71	155
CB2001T	-	Work Bench Cabinet less top	72" x 30"	497.33	175

**CLASS
C**

Premier
EDSAL

MODULAR DRAWER BENCHES



CATALOG PAGE 111



BENCH TYPE (A)

BENCH TYPE (B)

BENCH TYPE (C)

Bench Type	Product Number	Description	Size (W x D)	List Price Ea.	Approx. Shpg. Wt.
A	MDPM405	Workstation Complete With Maple Top	60" x 30"	3,011.62	467
B	MDPM406	Workstation Complete With Maple Top	60" x 30"	1,761.46	297
C	MDPM407	Workstation Complete With Maple Top	60" x 30"	1,919.55	317
A	MDPS408	Workstation Complete With Shop Top	60" x 30"	2,873.11	468
B	MDPS409	Workstation Complete With Shop Top	60" x 30"	1,622.94	298
C	MDPS410	Workstation Complete With Shop Top	60" x 30"	1,781.02	318
A	MDPL411	Workstation Complete With Plastic Lam. Top	60" x 30"	2,902.93	471
B	MDPL412	Workstation Complete With Plastic Lam. Top	60" x 30"	1,652.74	301
C	MDPL413	Workstation Complete With Plastic Lam. Top	60" x 30"	1,810.83	321
A	MDPM414	Workstation Complete With Maple Top	72" x 30"	3,088.00	484
B	MDPM415	Workstation Complete With Maple Top	72" x 30"	1,840.89	314
C	MDPM416	Workstation Complete With Maple Top	72" x 30"	1,998.97	334
A	MDPS417	Workstation Complete With Shop Top	72" x 30"	2,909.75	485
B	MDPS418	Workstation Complete With Shop Top	72" x 30"	1,662.64	315
C	MDPS419	Workstation Complete With Shop Top	72" x 30"	1,820.72	335
A	MDPL420	Workstation Complete With Plastic Lam. Top	72" x 30"	2,942.07	489
B	MDPL421	Workstation Complete With Plastic Lam. Top	72" x 30"	1,694.95	319
C	MDPL423	Workstation Complete With Plastic Lam. Top	72" x 30"	1,853.03	339



**CLASS
C**

Premier
BY ED/SAL

MODULAR DRAWER PEDESTAL COMPONENTS

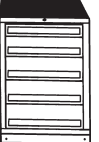
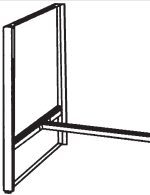
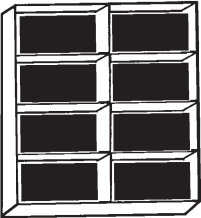

CATALOG PAGE 111

Component Picture	Model No	Description	List Ea.	Appr. Shpg. Wt.
	MDP4	Modular 4 Drawer Pedestal Unit	1,234.16	180
	MDP5	Modular 5 Drawer Pedestal Unit	1,392.25	200
	PL6	Stringer & Side Panel for Pedestal Workstation (For 60" Wide Table)	142.07	30
	PL7	Stringer & Side Panel for Pedestal Workstation (For 72" Wide Table)	145.13	30
	PDK3	Pedestal Divider Kit for 2" and 3" H Drawer	29.53	3.4
	PDK4	Pedestal Divider Kit for 4" H Drawer	32.14	4.1
	PDK12	Pedestal Divider Kit for 12" H Drawer	63.14	12.7

**CLASS
C**

Premier
BY ED/SAL

CABINET TABLES



CATALOG PAGE 112

PCT7811

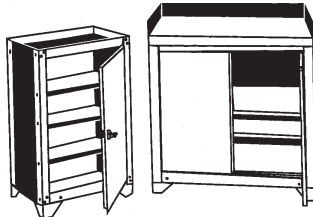

PCT7810

Product #	W" x D" x H"	List Ea.	Shpg.Wt.
PCT7810	34 x 25 x 37	473.04	114
PCT7811	21 x 15 1/2 x 34	255.33	57

**CLASS
C**

CABINET TABLES



CATALOG PAGE 112

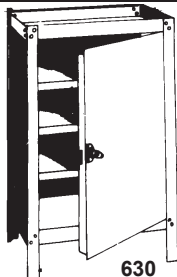

630

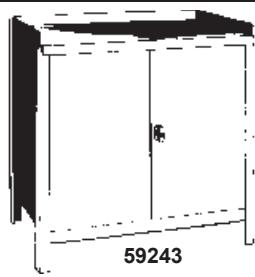

59243



59242

Product #	W" x D" x H"	List Ea.	Shpg.Wt.
630	21 x 15 1/2 x 34	199.53	46.0
59242	24 x 24 x 34	304.74	80.0
59243	36 x 24 x 34	393.70	110.0

**CLASS
C**

WORK TABLES



CATALOG PAGE 113

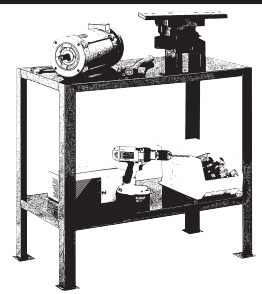

Product #	Size	List Ea.	Shpg. Wt.
WMT3618	36" x 18" x 32"	186.30	52.0
WMT3624	36" x 24" x 32"	207.33	66.0
WMT4824	48" x 24" x 32"	235.27	85.0
WMT6030	60" x 30" x 32"	291.88	126.0

**CLASS
C**

WORK TABLES



CATALOG PAGE 113

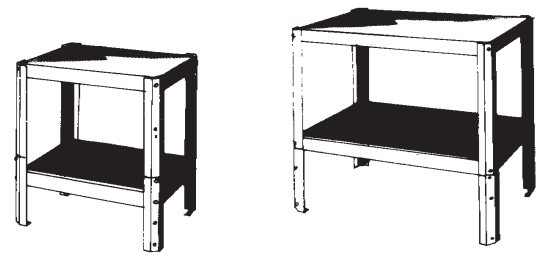

Product #	Top size	Ht. Range	List Ea.	Shpg. Wt.
WT-1824-18	18" x 24"	18"-24"	115.59	23.0
WT-1824-30	18" x 24"	30"-36"	125.86	26.0
WT-2430-18	24" x 30"	18"-24"	143.87	29.0
WT-2430-30	24" x 30"	30"-36"	154.63	32.0
WT-2436-18	24" x 36"	18"-24"	157.82	32.0
WT-2436-30	24" x 36"	30"-36"	168.59	35.0
WT-2448-18	24" x 48"	18"-24"	180.69	38.0
WT-2448-30	24" x 48"	30"-36"	191.44	41.0

**CLASS
C**

SHOP DESKS



CATALOG PAGE 114

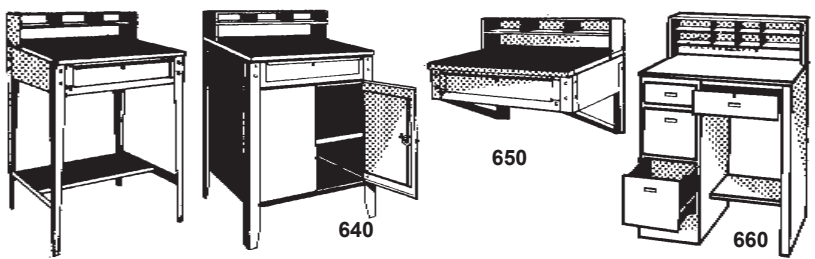

Product Number	Product Size W" x D" x H"	List Price Each Item	Approx. Shpg. Wt.	Freight Class
620	34 1/2 x 30 x 53	378.13	105	70
640	34 1/2 x 30 x 53	634.32	150	70
650	34 1/2 x 30 x 32 1/2	324.34	85	70
660	39 x 28 3/4 x 55 1/2	1,151.57	163	125
CL-10	Cylinder Lock	12.83	0.5	UPS

**CLASS
C**

Premier SHOP DESKS



CATALOG PAGE 115

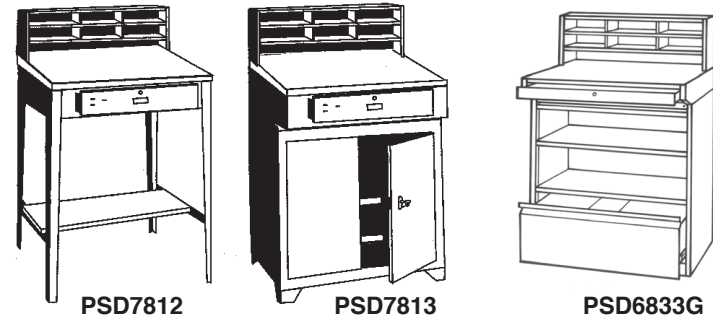

Product Number	Color	Product Size W" x D" x H"	List Price Each Item	Approx. Shpg. Wt.	Freight Class
PSD7812	Beige	34 x 30 1/4 x 55 1/2	435.35	106	70
PSD7813	Beige	34 x 30 1/4 x 55 1/2	699.06	155	70
PSD6833G	Gray	35 x 30 x 51	1,265.19	178	125

**CLASS
C**

SERVICE WRITER

125 

CATALOG PAGE 116

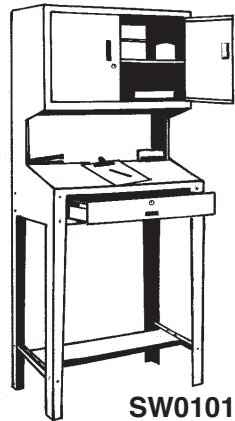

SW01010

Product Number	Description W" x D" x H"	List Price Each Item	Approx. Shpg. Wt.
SW01010T Tan	Open Service Writer 31½ x 21 x 72½	544.03	127
SW02010T Tan	Closed Service Writer 31½ x 21 x 72½	734.80	171
SW01010G Gray	Open Service Writer 31½ x 21 x 72½	544.03	127
SW02010G Gray	Closed Service Writer 31½ x 21 x 72½	734.80	171

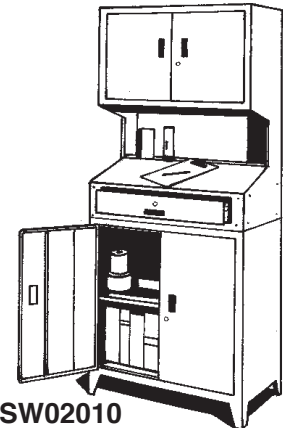

SW02010

**CLASS
C**

WALL DESK

70 

CATALOG PAGE 116

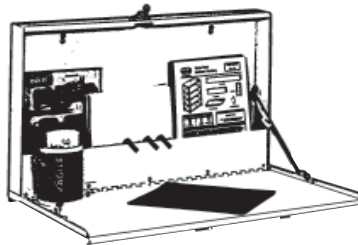

Product Number	Description W" x D" x H"	List Price Each Item	Approx. Shpg. Wt.
WDMB20047	Wall Desk 27"x4"x18"	203.99	22.0

**CLASS
C**

MODULAR WORKSPACE STORAGE SYSTEM

70 

CATALOG PAGE 117

Modular Workspace Storage System

Product #	DESCRIPTION	Size - W" x D" x H	List Ea.	Wt. Ea.
CB721836	Storage Cabinet	36" x 18" x 72"	366.52	115.0
CBD1836	Storage Cabinet Dolly	36" x 18" x 4"	68.40	22.0
WCS123131	Wall Cabinet	30" x 12" x 30"	262.15	50.0
603ST2584	Work Bench	84" x 25" x 36"	329.45	147.0
PMB782C	Mobile 2-Door Cabinet	28" x 22" x 30"	372.72	80.0
PMB783D	Mobile Tool Cabinet	23" x 22" x 30"	464.62	90.0

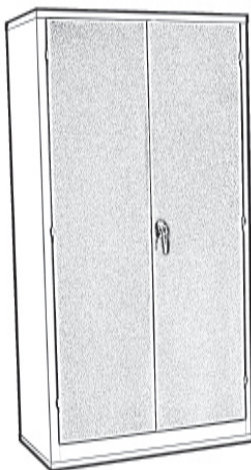

CB721836

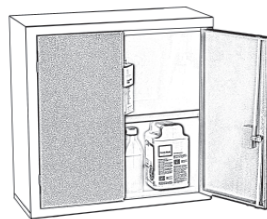

WCS123131



CBD1836



603ST2584

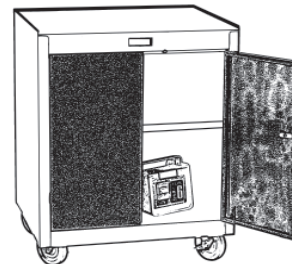

PMB782C

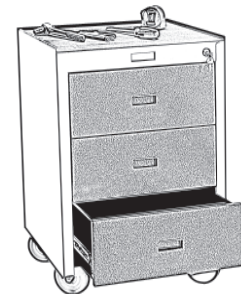

PMB783D

CLASS C

INDUSTRIAL SEATING



CATALOG PAGES 118 & 119

STOOLS



Model No.	Description	Qty. Per Pack	List Price Each	Shpg. Wt. (Lbs.)
Stools				
SS400	Steel/ Hardboard Seat Stool, Fixed Leg, 24" Hgt	2	-	9
SS401	Steel/ Hardboard Seat Stool, Fixed Leg, 30" Hgt	2	-	10
SS402	Steel/ Hardboard Round Seat Stool w/Adjustable Backrest and Adjustable Leg, 24"-33" Height	2	-	17
SS403	Steel/ Hardboard Square Scroll Seat with Steel Backrest and Adjustable Legs, 18"-27" Height	2	-	19
SS404	Steel/ Hardboard Round Seat Stool w/Adjustable Backrest and Adjustable Leg, 24"-33" Height	2	-	17
SS405	Steel/ Hardboard Square Scroll Seat with Adjustable Backrest and Adjustable Legs, 24"-33" Height	2	-	19
SS406	Upholstered Polyfoam Round Seat Stool with Adjustable Upholstered Backrest and Adjustable Legs, 18"-27" Height	2	-	17
SS407	Upholstered Polyfoam Round Seat Stool with Adjustable Upholstered Backrest and Adjustable Legs, 24"-33" Height	2	-	17
Swivel Chairs				
SS408	Brown Swivel Chair, 23"-31" Height	1	238.76	28
SS409	Black Swivel Chair, 23"-31" Height	1	238.76	28

*Stools must be ordered in carton quantity only

CLASS C

PREMIUM DUTY STOOLS



CATALOG PAGE 119



Model Number	Description	List Each	Shpg. Wt.
SS520	Grey Fabric Production Stool	-	31
SS521	Black/Vinyl Production Stool	-	31
SS522	Seat Casters (Optional)	-	4
SS524	Grey Fabric Deluxe Production Stool w/o Arms	-	29
SS526	Blue Fabric Deluxe Production Stool w/o Arms	-	29
SS527	Black Fabric Ergonomic Stool w/o Arms	-	42
SS528	Adjustable Arm Kit for SS527	-	9

CLASS C

COMPUTER WORK STATIONS



CATALOG PAGE 120

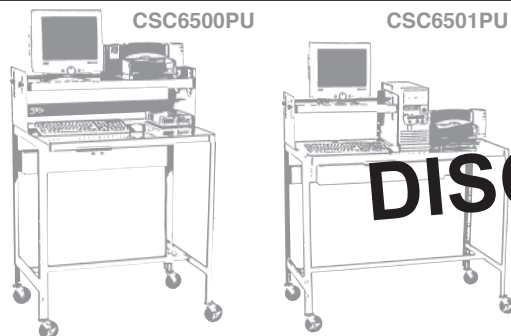

Product Number	Description	List Price Ea. Item	Approx. Shpg. Wt.
CSC6500PU	Computer Work Station 36" x 24" x 26-39 3/4"	-	66.0
CSC6501PU	Computer Work Station 48" x 24" x 26-39 3/4"	-	78.0

**CLASS
C**

COMPUTER ENCLOSURES



CATALOG PAGE 120

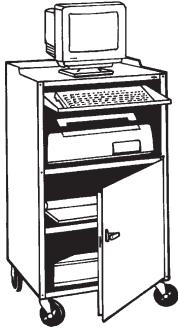

CSC6775(B/G)

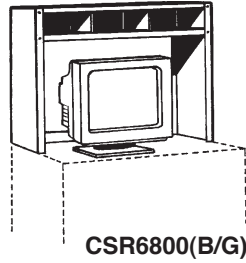

CSR6800(B/G)

COMPUTER STANDS

Product Number		Size-W" xD" xH"	List Ea.	Wt.
Blue	Gray			
CSC6775B	CSC6775G	27"W x 24"D x 49 ¹ / ₄ "H	587.82	125.0

COMPUTER STAND RISERS				
CSR6800B	CSR6800G	27"W x 13"D x 21"H	98.51	25.0

**CLASS
C**

COMPUTER ENCLOSURES



CATALOG PAGE 121

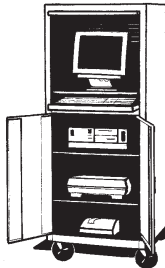

Product Number	Description	List Price Ea. Item	Approx. Shpg. Wt.	Freight Class
CSC6726	Mobile Computer Cabinet, Blue/Gray Preassembled	1,178.67	149	125
CSC6790	Mobile Computer Cabinet, Black/Gray Unassembled	1,048.84	150	70

**CLASS
C**

COMPUTER ENCLOSURES



CATALOG PAGE 122 & 123

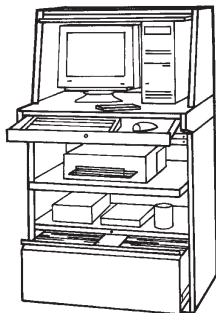

CSC6820G

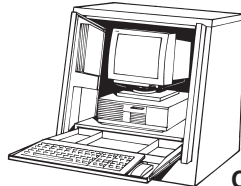

CSC6730

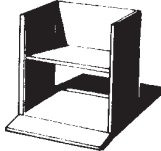

CSC6745

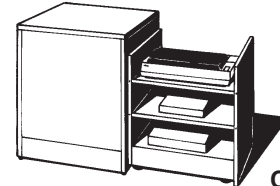

CSC6760

Product #	Description	Size (W x D x H)	List Ea.	Wt. Ea.	Ft. Class
CSC6820G	Premier Computer Enclosure, Gray	35" x 30" x 62"	1,331.36	196.0	125
CSC6730	Desk Top Computer Station, Blue	30" x 27 ³ / ₄ " x 30"	676.40	122.0	125
CSC6745	Open Pedestal Base, Blue	30" x 27 ³ / ₄ " x 32"	367.89	66.0	70
CSC6760	Printer Cart Base, Blue	30" x 27 ³ / ₄ " x 30"	836.99	142.0	70

**CLASS
C**

LCD MOBILE COMPUTER CABINET



CATALOG PAGE 123

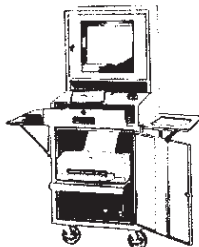

Product #	Description	Size	List Ea.	Wt. Ea.
CSC6625BLK	LCD Mobile Computer Cabinet, Black	24 ¹ / ₂ " x 22 ¹ / ₂ " x 62 ³ / ₄ "	681.36	108
CSC6625BU	LCD Mobile Computer Cabinet, Blue	24 ¹ / ₂ " x 22 ¹ / ₂ " x 62 ³ / ₄ "	681.36	108
CSC6625GY	LCD Mobile Computer Cabinet, Lt. Gray	24 ¹ / ₂ " x 22 ¹ / ₂ " x 62 ³ / ₄ "	681.36	108
CSC6625PU	LCD Mobile Computer Cabinet, Putty	24 ¹ / ₂ " x 22 ¹ / ₂ " x 62 ³ / ₄ "	681.36	108

**CLASS
C**

COMPUTER ENCLOSURES



CATALOG PAGE 124

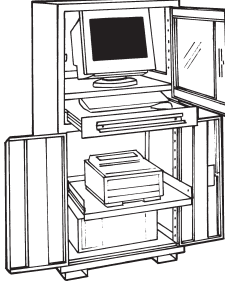

Product Number	Description W x D x H	List Price Ea. Item	Shipping Wt.
CSC6850	Premier Computer Enclosure 28 ¹ / ₄ " x 28 ¹ / ₂ " x 60"	1,612.87	255.0
CSC6852	Optional Caster Base	147.25	38.0 UPS

**CLASS
C**

COMPUTER ENCLOSURES



CATALOG PAGE 124

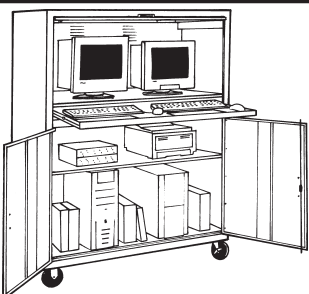

Product Number	Description W x D x H	List Price Ea. Item	Shipping Wt.
CSC6718	Computer Cabinet 50" x 24" x 64"	1,557.16	285.0

**CLASS
C**

COMPUTER ENCLOSURES



CATALOG PAGE 125

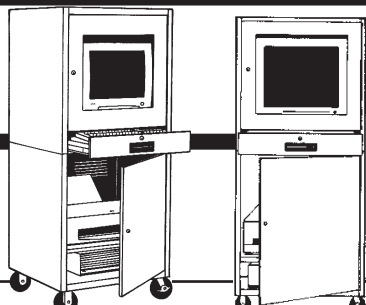

Model No.	Description	List Each	Weight Each
CSC6900BLK	Computer Cabinet, 21"W x 22 ¹ / ₂ "D x 59 ¹ / ₂ "H, (Ships in 2 Cartons), Black	\$641.41	100.0
CSC6900BU	Computer Cabinet, 21"W x 22 ¹ / ₂ "D x 59 ¹ / ₂ "H, (Ships in 2 Cartons), Blue	\$641.41	100.0
CSC6900GY	Computer Cabinet, 21"W x 22 ¹ / ₂ "D x 59 ¹ / ₂ "H, (Ships in 2 Cartons), Light Gray	\$641.41	100.0
CSC6900PU	Computer Cabinet, 21"W x 22 ¹ / ₂ "D x 59 ¹ / ₂ "H, (Ships in 2 Cartons), Putty	\$641.41	100.0

**CLASS
C**

COMPUTER ENCLOSURES



CATALOG PAGE 125

Product Number	Description W x D x H	List Price Ea. Item	Shipping Wt.
CSC6780	Computer Stand 50" x 24" x 49 ¹ / ₄ "	1,104.84	230.0



**CLASS
D**

CABINETTE STORAGE CABINETS

Unassembled



CATALOG PAGE 127

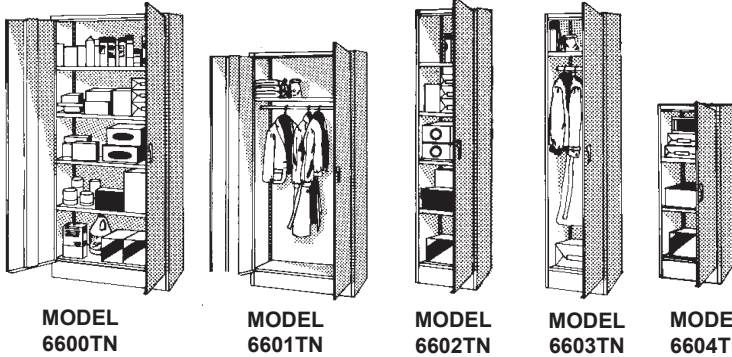

Product Number	Product Size W" x D" x H"	List Price Ea.	Approx. Shp. Wt.
DOUBLE DOOR STORAGE			
6600TN	30 x 15 x 66	297.15	83
66STN*	30 x 15 (Add'l Shelf Only)	14.59	5
DOUBLE DOOR WARDROBE			
6601TN	30 x 18 x 66	297.14	77
SINGLE DOOR STORAGE			
6602TN	18 x 18 x 66	270.12	63
67STN*	18 x 18 (Add'l Shelf Only)	10.90	4
SINGLE DOOR WARDROBE			
6603TN	18 x 18 x 66	262.82	54
SINGLE DOOR STORAGE			
6604TN	18 x 18 x 42	203.59	41
6605TN	21 x 15 x 35	174.97	35

*Shelves are packed 2 in a carton. Must be ordered in carton quantities.

**CLASS
D**

STORAGE CABINETS

Commercial Grade/Unassembled



CATALOG PAGES 128 & 129

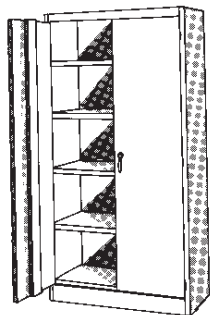

STORAGE

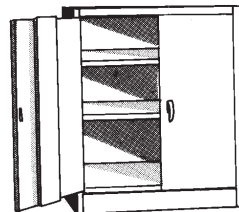

COUNTER HEIGHT

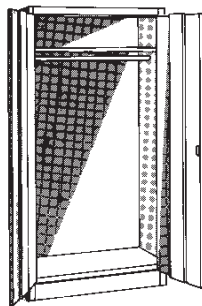

WARDROBE

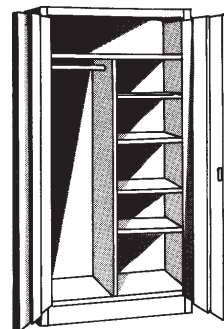

COMBINATION

Product Number	Product Size W" x D" x H"	Color	List Price Ea.	Shpg. Wt. (Lbs.)
STORAGE				
7000GY	36 x 18 x 72	Gray	392.08	110
7000TN	36 x 18 x 72	Tan	392.08	110
7000BLK	36 x 18 x 72	Black	392.08	110
7005GY	36 x 24 x 72	Gray	466.60	130
7005TN	36 x 24 x 72	Tan	466.60	130
7005BLK	36 x 24 x 72	Black	466.60	130
COUNTER HEIGHT				
7001GY	36 x 18 x 42	Gray	305.82	75
7001TN	36 x 18 x 42	Tan	305.82	75
7001BLK	36 x 18 x 42	Black	305.82	75
ADDITIONAL SHELVES ONLY				
7002GY	36 x 18	Gray	26.58	7
7002TN	36 x 18	Tan	26.58	7
7002BLK	36 x 18	Black	26.58	7
7006GY	36 x 24	Gray	34.47	9
7006TN	36 x 24	Tan	34.47	9
7006BLK	36 x 24	Black	34.47	9
WARDROBE				
7003GY	36 x 18 x 72	Gray	368.62	92
7003TN	36 x 18 x 72	Tan	368.62	92
7003BLK	36 x 18 x 72	Black	368.62	92
COMBINATION				
7004GY	36 x 18 x 72	Gray	417.28	115
7004TN	36 x 18 x 72	Tan	417.28	115
7004BLK	36 x 18 x 72	Black	417.28	115

CLASS D

STORAGE CABINETS

Commercial Grade/Set-Up



CATALOG PAGES 128 & 129

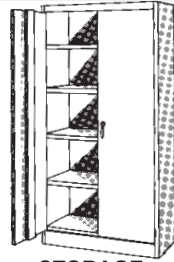

STORAGE

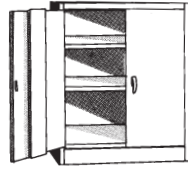

COUNTER HEIGHT

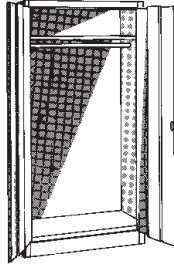

WARDROBE

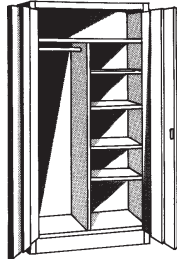

COMBINATION

Product Number	Size W" x D" x H"	Color	List Ea.	Shpg. Wt.
STORAGE				
7007GY	36" x 18" x 72"	Gray	466.61	110
7007TN	36" x 18" x 72"	Tan	466.61	110
7007BLK	36" x 18" x 72"	Black	466.61	110
7008GY	36" x 24" x 72"	Gray	554.96	130
7008TN	36" x 24" x 72"	Tan	554.96	130
7008BLK	36" x 24" x 72"	Black	554.96	130
COUNTER HEIGHT				
7009GY	36" x 18" x 42"	Gray	365.37	75
7009TN	36" x 18" x 42"	Tan	365.37	75
7009BLK	36" x 18" x 42"	Black	365.37	75
COMBINATION				
7004GYSU	36" x 18" x 72"	Gray	497.13	115
7004TNSU	36" x 18" x 72"	Tan	497.13	115
7004BLSU	36" x 18" x 72"	Black	497.13	115

Product Number	Size W" x D" x H"	Color	List Ea.	Shpg. Wt.
WARDROBE				
7003GYSU	36" x 18" x 72"	Gray	439.13	92
7003TNSU	36" x 18" x 72"	Tan	439.13	92
7003BLSU	36" x 18" x 72"	Black	439.13	92
SHELVES ONLY				
7002GY	36" x 18"	Gray	26.58	7
7002TN	36" x 18"	Tan	26.58	7
7002BLK	36" x 18"	Black	26.58	7
7006GY	36" x 24"	Gray	34.47	9
7006TN	36" x 24"	Tan	34.47	9
7006BLK	36" x 24"	Black	34.47	9

CLASS D

STORAGE CABINETS

Industrial Grade/Unassembled



CATALOG PAGES 130 & 131

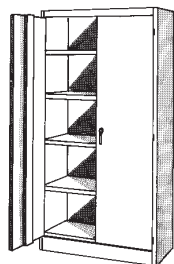

STORAGE

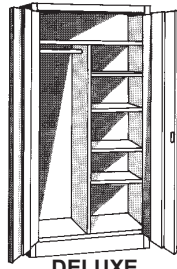

DELUXE COMBINATION

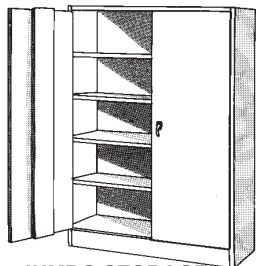

JUMBO STORAGE

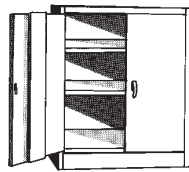

COUNTER HEIGHT

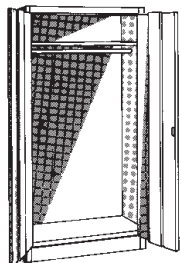

WARDROBE

Product Number	Size W" x D" x H"	Color	List Ea.	Shpg. Wt.
STORAGE				
3000GY	36 x 18 x 78	Gray	512.34	135
3000TN	36 x 18 x 78	Tan	512.34	135
3000BLK	36 x 18 x 78	Black	512.34	135
3001GY	36 x 24 x 78	Gray	571.19	161
3001TN	36 x 24 x 78	Tan	571.19	161
3001BLK	36 x 24 x 78	Black	571.19	161
COUNTER HEIGHT				
3006GY	36 x 18 x 42	Gray	371.32	90
3006TN	36 x 18 x 42	Tan	371.32	90
3006BLK	36 x 18 x 42	Black	371.32	90
3007GY	36 x 24 x 42	Gray	416.00	102
3007TN	36 x 24 x 42	Tan	416.00	102
3007BLK	36 x 24 x 42	Black	416.00	102
SHELVES ONLY				
3002GY	36 x 18	Gray	30.01	8
3002TN	36 x 18	Tan	30.01	8
3002BLK	36 x 18	Black	30.01	8
3003GY	36 x 24	Gray	36.88	11
3003TN	36 x 24	Tan	36.88	11
3003BLK	36 x 24	Black	36.88	11

Product Number	Size W" x D" x H"	Color	List Ea.	Shpg. Wt.
WARDROBE				
3011GY	36 x 18	Gray	286.69	135
3011TN	36 x 18	Tan	286.69	135
3011BLK	36 x 18	Black	286.69	135
3012GY	36 x 24	Gray	335.92	161
3012TN	36 x 24	Tan	335.92	161
3012BLK	36 x 24	Black	335.92	161

Product Number	Size W" x D" x H"	Color	List Ea.	Shpg. Wt.
DELUXE COMBINATION				
3004GY	36 x 18 x 78	Gray	568.71	159
3004TN	36 x 18 x 78	Tan	568.71	159
3004BLK	36 x 18 x 78	Black	568.71	159
3005GY	36 x 24 x 78	Gray	633.99	187
3005TN	36 x 24 x 78	Tan	633.99	187
3005BLK	36 x 24 x 78	Black	633.99	187
JUMBO STORAGE				
4000GY	48 x 24 x 78	Gray	733.39	215
4000TN	48 x 24 x 78	Tan	733.39	215
4000BLK	48 x 24 x 78	Black	733.39	215
4001GY	48 x 18 x 78	Gray	662.28	196
4001TN	48 x 18 x 78	Tan	662.28	196
4001BLK	48 x 18 x 78	Black	662.28	196
ADDITIONAL SHELVES ONLY				
4002GY	48 x 18	Gray	44.21	10
4002TN	48 x 18	Tan	44.21	10
4002BLK	48 x 18	Black	44.21	10
4003GY	48 x 24	Gray	53.91	12
4003TN	48 x 24	Tan	53.91	12
4003BLK	48 x 24	Black	53.91	12

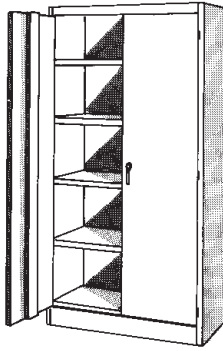

STORAGE

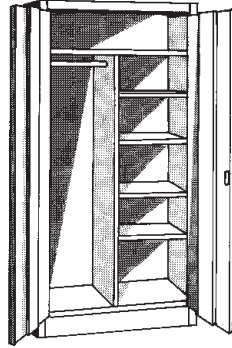

DELUXE COMBINATION

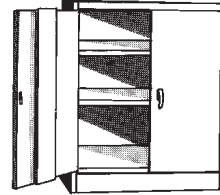

COUNTER HEIGHT

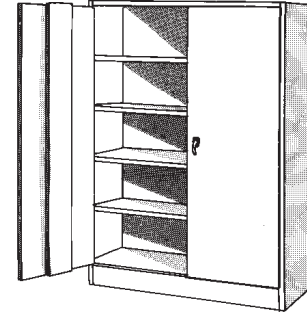

JUMBO STORAGE

Product Number	Size W" x D" x H"	Color	List Ea.	Shpg. Wt.
STORAGE				
3008GY	36 x 18 x 78	Gray	609.41	135
3008TN	36 x 18 x 78	Tan	609.41	135
3008BLK	36 x 18 x 78	Black	609.41	135
3009GY	36 x 24 x 78	Gray	679.37	161
3009TN	36 x 24 x 78	Tan	679.37	161
3009BLK	36 x 24 x 78	Black	679.37	161
DELUXE COMBINATION				
3004GYSU	36 x 18 x 78	Gray	677.55	159
3004TNSU	36 x 18 x 78	Tan	677.55	159
3004BLKSU	36 x 18 x 78	Black	677.55	159
3005GYSU	36 x 24 x 78	Gray	755.32	187
3005TNSU	36 x 24 x 78	Tan	755.32	187
3005BLSU	36 x 24 x 78	Black	755.32	187
COUNTER HEIGHT				
3006GYSU	36 x 18 x 42	Gray	442.38	90
3006TNSU	36 x 18 x 42	Tan	442.38	90
3006BLKSU	36 x 18 x 42	Black	442.38	90
3007GYSU	36 x 24 x 42	Gray	495.61	102
3007TNSU	36 x 24 x 42	Tan	495.61	102
3007BLSU	36 x 24 x 42	Black	495.61	102

Product Number	Size W" x D" x H"	Color	List Ea.	Shpg. Wt.
JUMBO STORAGE				
4000GYSU	48 x 24 x 78	Gray	873.74	215
4000TNSU	48 x 24 x 78	Tan	873.74	215
4000BLSU	48 x 24 x 78	Black	873.74	215
4001GYSU	48 x 18 x 78	Gray	789.00	196
4001TNSU	48 x 18 x 78	Tan	789.00	196
4001BLSU	48 x 18 x 78	Black	789.00	196
SHELVES ONLY				
3002GY	36 x 18	Gray	30.01	8
3002TN	36 x 18	Tan	30.01	8
3002BLK	36 x 18	Black	30.01	8
3003GY	36 x 24	Gray	36.88	11
3003TN	36 x 24	Tan	36.88	11
3003BLK	36 x 24	Black	36.88	11
4002GY	48 x 18	Gray	44.21	10
4002TN	48 x 18	Tan	44.21	10
4002BLK	48 x 18	Black	44.21	10
4003GY	48 x 24	Gray	53.91	12
4003TN	48 x 24	Tan	53.91	12
4003BLK	48 x 24	Black	53.91	12

**CLASS
D**

Premier
BY ED^{SA}L

RADIUS CABINETS

Unassembled



CATALOG PAGES 132 & 133

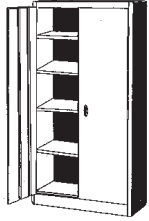

STORAGE
CABINET

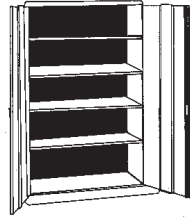

JUMBO
CABINET



WARDROBE
CABINET

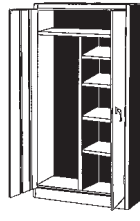

COMBINATION
CABINET

SHELVES ONLY

Product Number		Size W" x D" x H"	List Ea.	Shpg. Wt.
Gray	Putty			
7810LG	7810PU	36 x 18	31.00	8
7811LG	7811PU	36 x 24	41.24	10
7812LG	7812PU	48 x 18	45.05	10
7813LG	7813PU	48 x 24	54.94	12

Product Number	Size W" x D" x H"	Color	List Ea.	Shpg. Wt.
STORAGE CABINET				
7800LG	36 x 18 x 78	Light Gray	544.60	145
7800PU	36 x 18 x 78	Putty	544.60	145
7801LG	36 x 24 x 78	Light Gray	611.49	154
7801PU	36 x 24 x 78	Putty	611.49	154
JUMBO STORAGE CABINET				
7802LG	48 x 18 x 78	Light Gray	751.28	175
7802PU	48 x 18 x 78	Putty	751.28	175
7803LG	48 x 24 x 78	Light Gray	832.09	198
7803PU	48 x 24 x 78	Putty	832.09	198
WARDROBE CABINET				
7804LG	36 x 18 x 78	Light Gray	507.15	122
7804PU	36 x 18 x 78	Putty	507.15	122
7805LG	36 x 24 x 78	Light Gray	568.03	129
7805PU	36 x 24 x 78	Putty	568.03	129
COMBINATION CABINET				
7806LG	36 x 18 x 78	Light Gray	608.60	142
7806PU	36 x 18 x 78	Putty	608.60	142
7807LG	36 x 24 x 78	Light Gray	678.48	147
7807PU	36 x 24 x 78	Putty	678.48	147

**CLASS
D**

Premier
BY ED^{SA}L

RADIUS CABINETS

Set-Up



CATALOG PAGES 132 & 133

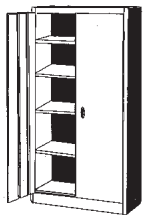

STORAGE
CABINET

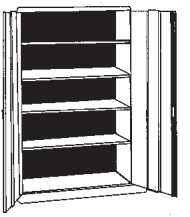

JUMBO
CABINET



WARDROBE
CABINET

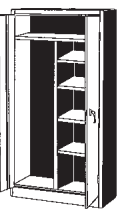

COMBINATION
CABINET

SHELVES ONLY

Product Number		Size W" x D" x H"	List Ea.	Shpg. Wt.
Gray	Putty			
7810LG	7810PU	36 x 18	31.00	8
7811LG	7811PU	36 x 24	41.24	10
7812LG	7812PU	48 x 18	45.05	10
7813LG	7813PU	48 x 24	54.94	12

Set-Up Product Number	Size W" x D" x H"	Color	List Ea.	Shpg. Wt.
STORAGE CABINET				
7800LGSU	36 x 18 x 78	Light Gray	648.80	145
7800PUSU	36 x 18 x 78	Putty	648.80	145
7801LGSU	36 x 24 x 78	Light Gray	728.48	154
7801PUSU	36 x 24 x 78	Putty	728.48	154
JUMBO STORAGE CABINET				
7802LGSU	48 x 18 x 78	Light Gray	899.24	175
7802PUSU	48 x 18 x 78	Putty	899.24	175
7803LGSU	48 x 24 x 78	Light Gray	995.97	198
7803PUSU	48 x 24 x 78	Putty	995.97	198
WARDROBE CABINET				
7804LGSU	36 x 18 x 78	Light Gray	604.20	122
7804PUSU	36 x 18 x 78	Putty	604.20	122
7805LGSU	36 x 24 x 78	Light Gray	676.71	129
7805PUSU	36 x 24 x 78	Putty	676.71	129
COMBINATION CABINET				
7806LGSU	36 x 18 x 78	Light Gray	725.07	142
7806PUSU	36 x 18 x 78	Putty	725.07	142
7807LGSU	36 x 24 x 78	Light Gray	808.28	147
7807PUSU	36 x 24 x 78	Putty	808.28	147

**CLASS
D**

STORAGE CABINET DOLLIES



CATALOG PAGE 133

Product Number	Size	List Each	Shpg. Wt.	Product Number	Size	List Each	Shpg. Wt.	Product Number	Size	List Each	Shpg. Wt.	Product Number	Size	List Each	Shpg. Wt.
CBD3618BLK	36"x18"	132.16	15.0	CBD3624BLK	36"x24"	152.78	17.0	CBD4818BLK	48"x18"	149.19	18.0	CBD4824BLK	48"x24"	172.45	24.0
CBD3618GY	36"x18"	132.16	15.0	CBD3624GY	36"x24"	152.78	17.0	CBD4818GY	48"x18"	149.19	18.0	CBD4824GY	48"x24"	172.45	24.0
CBD3618TN	36"x18"	132.16	15.0	CBD3624TN	36"x24"	152.78	17.0	CBD4818TN	48"x18"	149.19	18.0	CBD4824TN	48"x24"	172.45	24.0
CBD3618LG	36"x18"	132.16	15.0	CBD3624LG	36"x24"	152.78	17.0	CBD4818LG	48"x18"	149.19	18.0	CBD4824LG	48"x24"	172.45	24.0

**CLASS
D**

VISUAL CABINETS

**SET-UP
UNASSEMBLED**



CATALOG PAGES 134 & 135

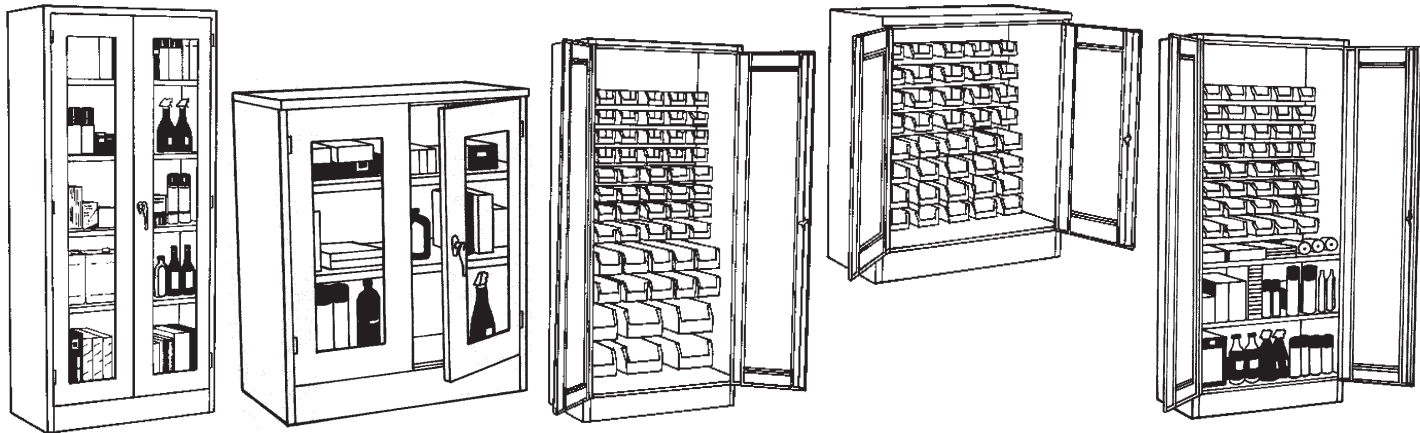



Model No.	Description	List Each	Weight Each
CV1250GY	Unassembled Visual Storage Cabinet with 2 Shelves, 36"W x 18"D x 42"H, Gray	556.31	90.0
CV1250TN	Unassembled Visual Storage Cabinet with 2 Shelves, 36"W x 18"D x 42"H, Tan	556.31	90.0
CV1251GY	Unassembled Visual Storage Cabinet with 4 Shelves, 36"W x 18"D x 78"H, Gray	827.22	152.0
CV1251TN	Unassembled Visual Storage Cabinet with 4 Shelves, 36"W x 18"D x 78"H, Tan	827.22	152.0
CV1252GY	Unassembled Visual Storage Cabinet with 4 Shelves, 36"W x 24"D x 78"H, Gray	932.97	176.0
CV1252TN	Unassembled Visual Storage Cabinet with 4 Shelves, 36"W x 24"D x 78"H, Tan	932.97	176.0
CV1253GY	Unassembled Visual Storage Cabinet with 4 Shelves, 48"W x 24"D x 78"H, Gray	1,109.78	208.0
CV1253TN	Unassembled Visual Storage Cabinet with 4 Shelves, 48"W x 24"D x 78"H, Tan	1,109.78	208.0
CV1254GY	Set-Up Visual Storage Cabinet with 2 Shelves, 36"W x 18"D x 42"H, Gray	645.48	90.0
CV1254TN	Set-Up Visual Storage Cabinet with 2 Shelves, 36"W x 18"D x 42"H, Tan	645.48	90.0
CV1255GY	Set-Up Visual Storage Cabinet with 4 Shelves, 36"W x 18"D x 78"H, Gray	953.88	152.0
CV1255TN	Set-Up Visual Storage Cabinet with 4 Shelves, 36"W x 18"D x 78"H, Tan	953.88	152.0
CV1256GY	Set-Up Visual Storage Cabinet with 4 Shelves, 36"W x 24"D x 78"H, Gray	1,073.58	176.0
CV1256TN	Set-Up Visual Storage Cabinet with 4 Shelves, 36"W x 24"D x 78"H, Tan	1,073.58	176.0
CV1257GY	Set-Up Visual Storage Cabinet with 4 Shelves, 48"W x 24"D x 78"H, Gray	1,269.77	208.0
CV1257TN	Set-Up Visual Storage Cabinet with 4 Shelves, 48"W x 24"D x 78"H, Tan	1,269.77	208.0
CV1258GY	Unassembled Visual Wall Mount Cabinet with 2 Shelves, 30"W x 12"D x 26"H, Gray	487.45	48.0
CV1258TN	Unassembled Visual Wall Mount Cabinet with 2 Shelves, 30"W x 12"D x 26"H, Tan	487.45	48.0
CV1259GY	Set-Up Visual Wall Mount Cabinet with 2 Shelves, 30"W x 12"D x 26"H, Gray	568.70	48.0
CV1259TN	Set-Up Visual Wall Mount Cabinet with 2 Shelves, 30"W x 12"D x 26"H, Tan	568.70	48.0
CV1260GY	Unassembled Visual Storage Cabinet with 48 Bins, 36"W x 18"D x 42"H, Gray	694.50	108.0
CV1260TN	Unassembled Visual Storage Cabinet with 48 Bins, 36"W x 18"D x 42"H, Tan	694.50	108.0
CV1261GY	Unassembled Visual Storage Cabinet with 66 Bins, 36"W x 18"D x 78"H, Gray	1,152.16	200.0
CV1261TN	Unassembled Visual Storage Cabinet with 66 Bins, 36"W x 18"D x 78"H, Tan	1,152.16	200.0
CV1262GY	Unassembled Visual Storage Cabinet with 66 Bins, 36"W x 24"D x 78"H, Gray	1,229.66	204.0
CV1262TN	Unassembled Visual Storage Cabinet with 66 Bins, 36"W x 24"D x 78"H, Tan	1,229.66	204.0
CV1263GY	Unassembled Visual Storage Cabinet with 48 Bins, 48"W x 24"D x 78"H, Gray	1,610.74	262.0
CV1263TN	Unassembled Visual Storage Cabinet with 48 Bins, 48"W x 24"D x 78"H, Tan	1,610.74	262.0
CV1264GY	Set-Up Visual Storage Cabinet with 48 Bins, 36"W x 18"D x 42"H, Gray	783.68	108.0
CV1264TN	Set-Up Visual Storage Cabinet with 48 Bins, 36"W x 18"D x 42"H, Tan	783.68	108.0
CV1265GY	Set-Up Visual Storage Cabinet with 66 Bins, 36"W x 18"D x 78"H, Gray	1,278.80	200.0
CV1265TN	Set-Up Visual Storage Cabinet with 66 Bins, 36"W x 18"D x 78"H, Tan	1,278.80	200.0
CV1266GY	Set-Up Visual Storage Cabinet with 66 Bins, 36"W x 24"D x 78"H, Gray	1,370.27	204.0
CV1266TN	Set-Up Visual Storage Cabinet with 66 Bins, 36"W x 24"D x 78"H, Tan	1,370.27	204.0
CV1267GY	Set-Up Visual Storage Cabinet with 48 Bins, 48"W x 24"D x 78"H, Gray	1,770.74	262.0
CV1267TN	Set-Up Visual Storage Cabinet with 48 Bins, 48"W x 24"D x 78"H, Tan	1,770.74	262.0
CV1268GY	Unassembled Visual Storage Cabinet with 2 Shelves and 48 Bins, 36"W x 18"D x 78"H, Gray	965.42	170.0
CV1268TN	Unassembled Visual Storage Cabinet with 2 Shelves and 48 Bins, 36"W x 18"D x 78"H, Tan	965.42	170.0
CV1269GY	Unassembled Visual Storage Cabinet with 2 Shelves and 48 Bins, 36"W x 24"D x 78"H, Gray	1,057.05	188.0
CV1269TN	Unassembled Visual Storage Cabinet with 2 Shelves and 48 Bins, 36"W x 24"D x 78"H, Tan	1,057.05	188.0
CV1270GY	Unassembled Visual Storage Cabinet with 2 Shelves and 20 Bins, 48"W x 24"D x 78"H, Gray	1,559.52	244.0
CV1270TN	Unassembled Visual Storage Cabinet with 2 Shelves and 20 Bins, 48"W x 24"D x 78"H, Tan	1,559.52	244.0
CV1271GY	Set-Up Visual Storage Cabinet with 2 Shelves and 48 Bins, 36"W x 18"D x 78"H, Gray	1,092.08	170.0
CV1271TN	Set-Up Visual Storage Cabinet with 2 Shelves and 48 Bins, 36"W x 18"D x 78"H, Tan	1,092.08	170.0
CV1272GY	Set-Up Visual Storage Cabinet with 2 Shelves and 48 Bins, 36"W x 24"D x 78"H, Gray	1,197.66	244.0
CV1272TN	Set-Up Visual Storage Cabinet with 2 Shelves and 48 Bins, 36"W x 24"D x 78"H, Tan	1,197.66	244.0

**CLASS
D**

VISUAL CABINETS

(Continued from p. 69)

SET-UP  125
UNASSEMBLED  100
CATALOG PAGES 134 & 135

Model No.	Description	List Each	Weight Each
CV1273GY	Set-Up Visual Storage Cabinet with 2 Shelves and 20 Bins, 48"W x 24"D x 78"H, Gray	1,719.50	244.0
CV1273TN	Set-Up Visual Storage Cabinet with 2 Shelves and 20 Bins, 48"W x 24"D x 78"H, Tan	1,719.50	244.0
CV1274GY	Unassembled Visual Wall Mount Cabinet with 24 Bins, 30"W x 12"D x 26"H, Gray	563.57	58.0
CV1274TN	Unassembled Visual Wall Mount Cabinet with 24 Bins, 30"W x 12"D x 26"H, Tan	563.57	58.0
CV1275GY	Set-Up Visual Wall Mount Cabinet with 24 Bins, 30"W x 12"D x 26"H, Gray	644.81	58.0
CV1275TN	Set-Up Visual Wall Mount Cabinet with 24 Bins, 30"W x 12"D x 26"H, Tan	644.81	58.0
CVP30GY	Louvered Panel Kit for 30"W Visual Wall Mount Cabinets, (2) 15"W x 23"H, Gray	51.67	13.0
CVP30TN	Louvered Panel Kit for 30"W Visual Wall Mount Cabinets, (2) 15"W x 23"H, Tan	51.67	13.0
CVP36GY	Louvered Panel Kit for 36"W Visual Cabinets, (2) 18"W x 33"H, Gray	61.86	19.0
CVP36TN	Louvered Panel Kit for 36"W Visual Cabinets, (2) 18"W x 33"H, Tan	61.86	19.0
CVP48GY	Louvered Panel Kit for 48"W Visual Cabinets, (2) 24"W x 33"H, Gray	63.54	25.0
CVP48TN	Louvered Panel Kit for 48"W Visual Cabinets, (2) 24"W x 33"H, Tan	63.54	25.0

**CLASS
D**

SAFETY CABINETS

125 

CATALOG PAGE 136

**TWO DOOR
MANUAL CLOSE**

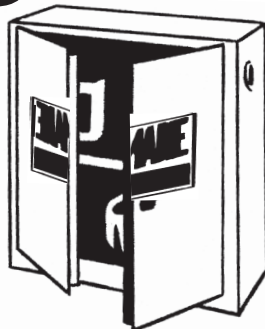

SC300F

SC450F

Model Number	Description	List Each	Weight Each
SC300F	30 Gallon Safety Cabinet, Double Door, Manual Close, 1 Shelf, 43"W x 18"D x 44"H	1,054.98	252.0
SC450F	45 Gallon Safety Cabinet, Double Door, Manual Close, 2 Shelves, 43"W x 18"D x 65"H	1,312.66	349.0
SC600F	60 Gallon Safety Cabinet, Double Door, Manual Close, 2 Shelves, 34"W x 34"D x 65"H	1,570.03	409.0
SCS350F	Additional Galvanized Shelf for #SC300F & SC450F Safety Cabinets, 39-3/8"W x 14"D	73.31	9.0
SCS650F	Additional Galvanized Shelf for #SC600F Safety Cabinets, 30-3/8"W x 30"D	139.83	12.0

**CLASS
D**

SAFETY CABINETS

125 

CATALOG PAGE 136



SWH24F

Model No.	Description	List Each	Weight Each
SWH24F	24 Gallon Safety Cabinet, Double Door, Manual Close, 43"W x 12"D x 44"H	895.37	190.0
SCS24	Additional Shelf for #SWH24F Safety Cabinet, 39-3/8"W x 8"D	49.11	22.0

**SLIDING DOOR
SELF CLOSING**

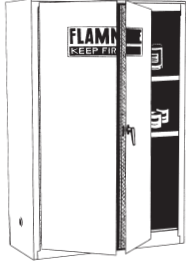

SCM745F

Model No.	Description	List Each	Wt. Each
SCM730F	30 Gallon Safety Cabinet, Sliding Door, Self Closing, 1 Shelf, 43"W x 18"D x 44"H	1,142.34	250.0
SCM745F	45 Gallon Safety Cabinet, Sliding Door, Self Closing, 2 Shelves, 43"W x 18"D x 65"H	1,421.25	350.0
SCM760F	60 Gallon Safety Cabinet, Sliding Door, Self Closing, 2 Shelves, 34"W x 34"D x 65"H	1,699.97	400.0
SCS350F	Additional Galvanized Shelf for #SCM730F & SCM745F Safety Cabinets, 39-3/8"W x 14"D	73.31	9.0
SCS650F	Additional Galvanized Shelf for #SCM760F Safety Cabinets, 30-3/8"W x 30"D	139.83	12.0

COMPACT



SC16F



SC22F

Model No.	Description	List Each	Wt. Each
SC12F	12 Gallon Compact Safety Cabinet, Single Door, Manual Close, 1 Shelf, 23"W x 18"D x 35"H	681.17	110.0
SC16F	16 Gallon Compact Safety Cabinet, Single Door, Manual Close, 1 Shelf, 23"W x 18"D x 44"H	805.13	130.0
SC22F	22 Gallon Compact Safety Cabinet, Double Door, Manual Close, 1 Shelf, 35"W x 22"D x 35"H	946.92	165.0

ACID



AC300A

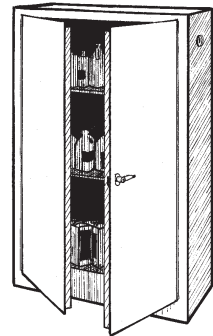

AC450A

Model No.	Description	List Each	Wt. Each
AC300A	30 Gallon Acid Cabinet, Double Door, Manual Close, 1 Shelf, 2 Trays, 43"W x 18"D x 44"H	1,149.93	253.0
AC450A	45 Gallon Acid Cabinet, Double Door, Manual Close, 2 Shelves, 3 Trays, 43"W x 18"D x 65"H	1,430.80	350.0
AC600A	60 Gallon Acid Cabinet, Double Door, Manual Close, 2 Shelves, 3 Trays, 34"W x 34"D x 65"H	1,711.30	410.0
ACM830A	30 Gallon Acid Cabinet, Sliding Door, Self Closing, 1 Shelf, 2 Trays, 43"W x 18"D x 44"H	1,237.29	251.0
ACM845A	45 Gallon Acid Cabinet, Sliding Door, Self Closing, 2 Shelves, 3 Trays, 43"W x 18"D x 65"H	1,539.39	351.0
ACM860A	60 Gallon Acid Cabinet, Sliding Door, Self Closing, 2 Shelves, 3 Trays, 34"W x 34"D x 65"H	1,841.25	401.0
ACS350A	Additional Shelf for #AC300A, AC450A, ACM830A & ACM845A Acid Cabinets, 39-3/8"W x 14"	93.88	10.0
ACS650A	Additional Shelf for #AC600A & ACM860A Acid Cabinets, 30-3/8"W x 30"D	162.18	13.0
ACT370A	Shelf Tray for #AC300A, AC450A, ACM830A & ACM845A Acid Cabinets, 39-3/8"W x 14"D	87.27	4.0
ACT670A	Shelf Tray for #AC600A & ACM860A Acid Cabinets, 30-3/8"W x 30"D	107.90	6.0

PAINT & INK

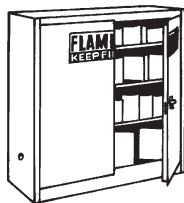

PC40

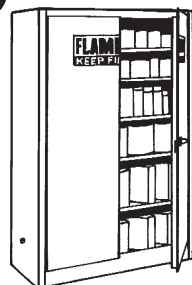

PC60

Model No.	Description	List Each	Wt. Each
PC40	40 Gallon Paint & Ink Cabinet, Double Door, Manual Close, 3 Shelves, 43"W x 18"D x 44"H	1,201.61	270.0
PC60	60 Gallon Paint & Ink Cabinet, Double Door, Manual Close, 5 Shelves, 43"W x 18"D x 65"H	1,532.62	385.0
PCM940	40 Gallon Paint & Ink Cabinet, Sliding Door, Self Closing, 3 Shelves, 43"W x 18"D x 44"H	1,288.96	269.0
PCM960	60 Gallon Paint & Ink Cabinet, Sliding Door, Self Closing, 5 Shelves, 43"W x 18"D x 65"H	1,641.19	378.0
SCS350F	Additional Galvanized Shelf for #PC40, PC60, PCM940 & PCM960 Cabinets, 39-3/8"W x 14"	73.31	9.0

**CLASS
C**

Premier
BY ED^SAL

MODULAR DRAWER CABINETS



CATALOG PAGE 139

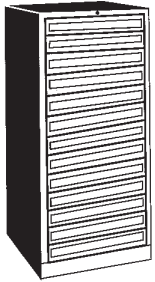

MDC13

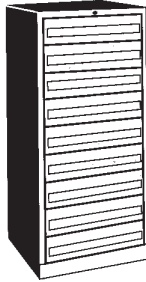

MDC9

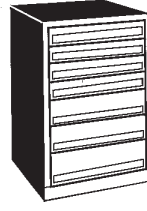

MDC7

Product Number	Description	List Each	Shpg. Wt.
MDC13	Modular Drawer Cabinet With 13 Drawers (See Catalog for Specs)	3,547.99	485
MDC9	Modular Drawer Cabinet With 9 Drawers (See Catalog for Specs)	2,760.34	402
MDC7	Modular Drawer Cabinet With 7 Drawers (See Catalog for Specs)	2,080.58	298

**CLASS
C**

Premier
BY ED^SAL

OPTIONAL DRAWER DIVIDER KITS FOR MODULAR DRAWER CABINETS



CATALOG PAGE 139

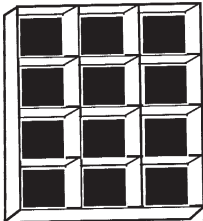

Product Number	Description	List Each	Shpg. Wt.
DDK2	Drawer Divider Kit for Drawer Size 2 ⁵ / ₈ & 3 ¹ / ₈ " H	39.04	4.6
DDK3	Drawer Divider Kit for Drawer Size 5 ¹ / ₄ " H	46.13	7.0
DDK4	Drawer Divider Kit for Drawer Size 7 ¹ / ₄ " H	50.94	9.1

**CLASS
D**

STANDARD WELDED BIN STORAGE CABINETS



CATALOG PAGE 140

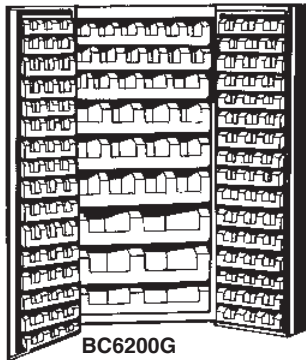

BC6200G



BC6201G



BC6202G

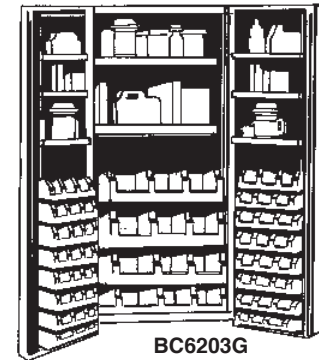

BC6203G

Product Number	Description	Size W" x D" x H"	Total No. Of Bins	List Price Each	Approx. Sh. Wt.
BC6200G	Std. Pocket Door Cabinet With Bins	38x24x72	132	2,263.57	399
BC6201G	Std. Pocket Door Cabinet With Shelves	38x24x72	—	1,655.60	306
BC6202G	Std. Pocket Door Cabinet W/Shelves & Bins	38x24x72	96	1,879.79	374
BC6203G	Std. Pocket Door Cabinet W/Shelves & Bins	38x24x72	64	1,992.27	358



**CLASS
D**

JUMBO WELDED BIN STORAGE CABINETS



CATALOG PAGE 141

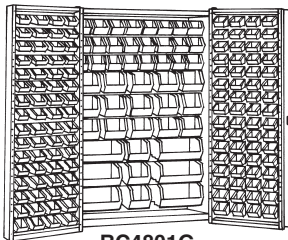

BC4801G



BC4802G

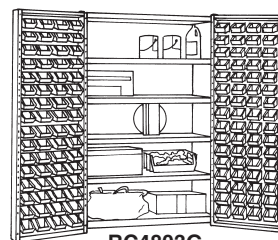

BC4803G

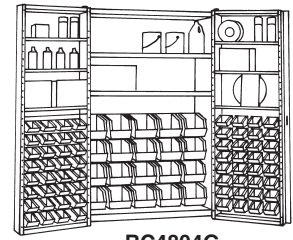

BC4804G

Product #	Description	Size W" x D" x H"	Total No. of Bins	List Each	Shpg.Wt.
BC4801G	Jumbo Pocket Door Cabinet With Bins	48x24x72	176	2,858.74	530
BC4802G	Jumbo Pocket Door Cabinet With Shelves	48x24x72	—	2,055.99	428
BC4803G	Jumbo Pocket Door Cabinet W/Shelves & Bins	48x24x72	128	2,360.37	496
BC4804G	Jumbo Pocket Door Cabinet W/Shelves & Bins	48x24x72	84	2,486.95	451

**CLASS
D**

WELDED FLUSH DOOR CABINETS



CATALOG PAGE 142

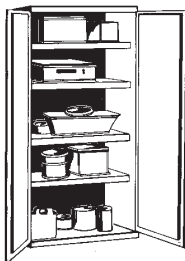

BC6204G

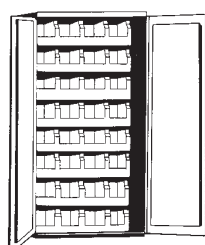

BC6205G

Product Number	Description	Size W" x D" x H"	Total No. of Bins	List Each	Shpg. Wt.
BC6204G	Flush Door Cabinet With Shelves	38x20x72	—	1,407.70	280
BC6205G	Flush Door Cabinet With Bins	38x20x72	30	1,752.34	282

**CLASS
D**

WELDED POCKET DOOR CABINETS



CATALOG PAGE 142

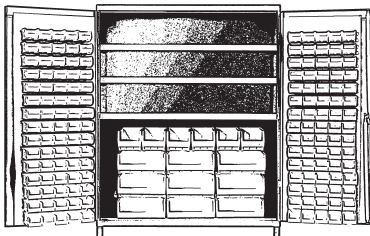

BC5610

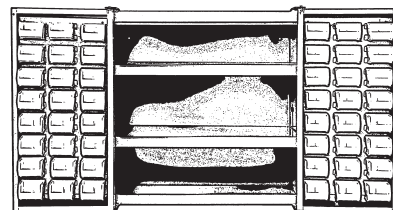

BC5720

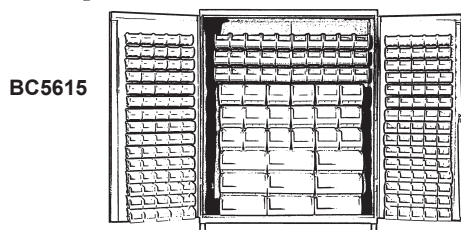

BC5615

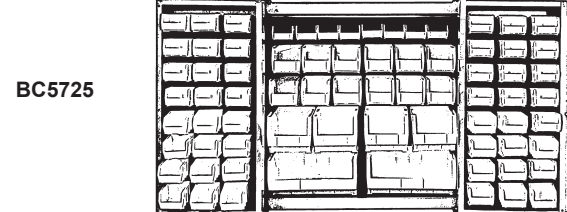

BC5725

Product Number	Description	Size W" x D" x H"	Total No. of Bins	List Each	Shpg.Wt.
BC5610	Pocket Door Cabinet With Shelves	60 x 24 x 84	185	1,867.26	830
BC5615	Pocket Door Cabinet	60 x 24 x 84	227	2,058.37	840
BC5720	Pocket Door Cabinet With Shelves	36 x 24 x 36	48	991.89	190
BC5725	Pocket Door Cabinet	36 x 24 x 36	74	1,172.22	220

**CLASS
D**

WELDED STORAGE CABINETS

Commercial Grade



CATALOG PAGE 143

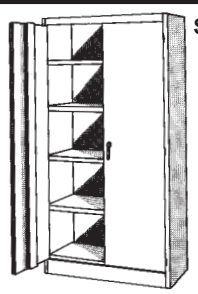

STORAGE



COUNTER HEIGHT

Product Number	Size W" x D" x H"	Color	List Each	Shpg. Wt.
WELDED STORAGE CABINETS				
WC183642GY	36" x 18" x 42"	Gray	394.83	85
WC183642PU	36" x 18" x 42"	Putty	394.83	85
WC183672GY	36" x 18" x 72"	Gray	489.96	138
WC183672PU	36" x 18" x 72"	Putty	489.96	138
WC243672GY	36" x 24" x 72"	Gray	603.72	181
WC243672PU	36" x 24" x 72"	Putty	603.72	181

Product Number	Size W" x D" x H"	Color	List Each	Shpg. Wt.
SHELVES ONLY				
7002GY	36" x 18"	Gray	26.58	7
7002PU	36" x 18"	Putty	26.58	7
7006GY	36" x 24"	Gray	34.47	9
7006PU	36" x 24"	Putty	34.47	9

**CLASS
D**

WELDED STORAGE CABINETS

Industrial Grade



CATALOG PAGE 143

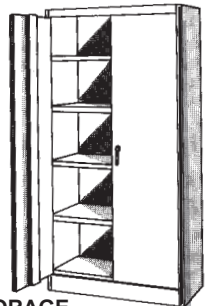

STORAGE

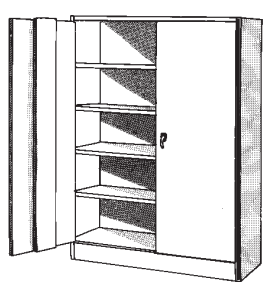

JUMBO STORAGE

WELDED CABINETS

Product Number		Size W" x D" x H"	List Ea.	Shpg. Wt.
Gray	Putty			
WC183678GY	WC183678PU	36"x18"x78"	742.60	186
WC243678GY	WC243678PU	36"x24" x78"	815.89	217
WC184878GY	WC184878PU	48"x18"x78"	962.44	273
WC244878GY	WC244878PU	48"x24"x78"	1,063.06	271

SHELVES ONLY

7810GY	7810PU	36 x 18	31.00	8
7811GY	7811PU	36 x 24	41.24	10
7812GY	7812PU	48 x 18	45.05	10
7813GY	7813PU	48 x 24	54.94	12

**CLASS
D**

VAULT CABINETS



CATALOG PAGE 143

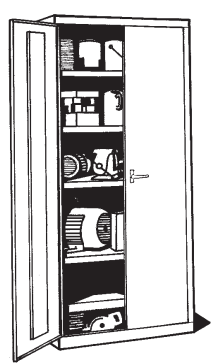

Product Number	Size W" x D" x H"	List Each	Shpg. Wt.
VC1500G	36 x 18 x 48	796.41	198
VC1501G	36 x 18 x 60	955.70	240
VC1502G	36 x 18 x 72	1,116.80	281
VC1503G	36 x 18 x 84	1,199.18	309
VC1504G	36 x 24 x 84	1,290.71	352
VC1505G	48 x 24 x 84	1,662.38	409
VC362448	36 x 24 x 48	737.81	210
VC362472	36 x 24 x 72	922.96	332
VC482472	48 x 24 x 72	1,109.98	370

VAULT CABINET SHELF

VCEX136G	36 x 18	69.47	18
VCEX236G	36 x 24	85.78	22
VCEX348G	48 x 24	112.60	27

**CLASS
D**

EXTRA HEAVY DUTY CABINETS



CATALOG PAGE 144



Product Number	Size W" x D" x H"	Color	List Each	Shpg. Wt.
EHD4236	36" x 24" x 42"	Gray	945.66	210.0
EHD7836	36" x 24" x 78"	Gray	1,484.90	363.0
EHD7848	48" x 24" x 78"	Gray	1,625.51	445.0
EHD7860	60" x 24" x 78"	Gray	1,765.90	526.0

**CLASS
D**

MOBILE STORAGE CABINETS



CATALOG PAGES 145

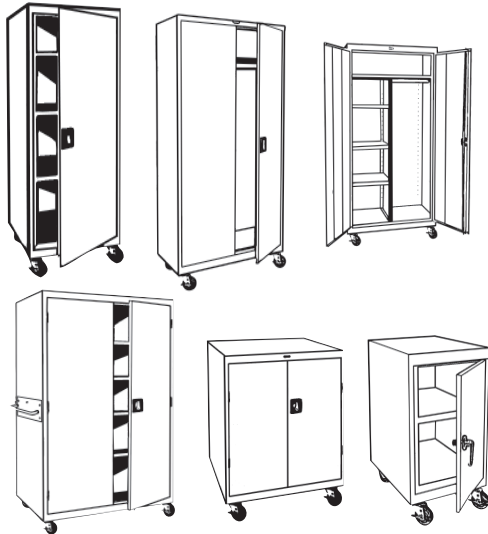

Product Number	Description	Size W" x D" x H"	List Each	Shpg. Wt.
TA4R302466-__	Transport Mobile Storage	30" x 24" x 72"	\$852.21	185.0
TA3R362460-__**	Transport Mobile Storage	36" x 24" x 66"	\$783.40	205.0
TA4R362472-__	Transport Mobile Storage	36" x 24" x 78"	\$920.30	213.0
TA3R462460-__**♦	Transport Mobile Storage	46" x 24" x 66"	\$1072.30	251.0
TA4R462472-__♦	Transport Mobile Storage	46" x 24" x 78"	\$1150.60	280.0
TA3R242460-__♦	Transport Mobile Storage	24" x 24" x 66"	\$758.60	154.0
TAWR362472-__	Transport Mobile Wardrobe	36" x 24" x 78"	\$869.20	188.0
TAWR462472-__♦	Transport Mobile Wardrobe	46" x 24" x 78"	\$1086.20	246.0
TACR362460-__	Transport Mobile Combination	36" x 24" x 66"	\$844.60	205.0
TACR362472-__	Transport Mobile Combination	36" x 24" x 78"	\$1011.40	213.0
TACR462472-__♦	Transport Mobile Combination	46" x 24" x 78"	\$1239.10	272.0
TA2R462442-__♦	Transport Work Height Storage	46" x 24" x 48"	\$753.60	213.0
TA11182430-__	Transport Work Height Storage	18" x 24" x 36"	\$489.20	88.0
TA11361830-__	Transport Work Height Storage	36" x 18" x 36"	\$542.80	108.0
TA11362430-__	Transport Work Height Storage	36" x 24" x 36"	\$557.40	128.0
TSH-__	Transport Side Handle	23" x 5" x 4"	\$84.30	6.0

Add one of the following suffix codes for color:

- 02 - Charcoal
- 04 - Sand
- 05 - Dove Gray
- 07 - Putty
- 09 - Black

*Height includes 6" for casters
•No top shelf

**Three adjustment sleeves
♦ Extra large capacity

**CLASS
D**

CITADEL INDUSTRIAL LOCKERS

Unassembled



Set-Up



RECESSED HANDLE CATALOG PAGES 147-149

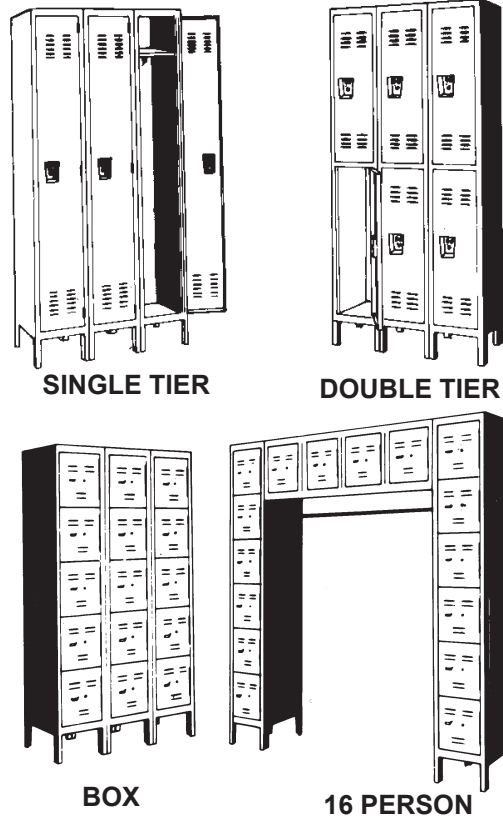

SINGLE TIER

DOUBLE TIER

BOX

16 PERSON

Overall height of locker frame is 60" or 72" - Add 6" for legs.
Add Product Number Suffix (BU) BLUE, (GY) GRAY or (TN) TAN.
All prices listed are per opening.

SEE PAGE 78 FOR ACCESSORIES

Product # Unassembled	Product # Set-Up	Description W" x D" x H"	List Price Per Opening Unassembled	List Price Per Opening Set-Up	Shpg. Wt.
Single Tier (1 Wide)					
CL5001	CL5501	1 Opening - 12 x 12 x 60	209.55	251.45	45
CL5011	CL5511	1 Opening - 12 x 15 x 60	219.20	263.04	48
CL5021	CL5521	1 Opening - 12 x 18 x 60	232.37	278.83	51
CL5031	CL5531	1 Opening - 12 x 12 x 72	231.18	277.42	51
CL5041	CL5541	1 Opening - 12 x 15 x 72	239.72	287.67	55
CL5051	CL5551	1 Opening - 12 x 18 x 72	254.14	304.98	59
CL5061	CL5561	1 Opening - 15 x 18 x 72	277.78	333.35	66
Single Tier (3 Wide)					
CL5003	CL5503	3 Openings - 12 x 12 x 60	174.71	209.64	135
CL5013	CL5513	3 Openings - 12 x 15 x 60	182.67	219.20	144
CL5023	CL5523	3 Openings - 12 x 18 x 60	193.65	232.37	153
CL5033	CL5533	3 Openings - 12 x 12 x 72	192.65	231.18	153
CL5043	CL5643	3 Openings - 12 x 15 x 72	199.97	239.98	165
CL5053	CL5553	3 Openings - 12 x 18 x 72	211.81	254.18	177
CL5063	CL5563	3 Openings - 15 x 18 x 72	231.40	277.70	198
Double Tier (1 Wide)					
CL5071	CL5571	2 Openings - 12 x 12 x 36	132.98	159.58	52
CL5081	CL5581	2 Openings - 12 x 15 x 36	139.64	167.58	56
CL5091	CL5591	2 Openings - 12 x 18 x 36	145.37	174.44	59
Double Tier (3 Wide)					
CL5073	CL5573	6 Openings - 12 x 12 x 36	110.79	132.94	156
CL5083	CL5583	6 Openings - 12 x 15 x 36	116.23	139.48	168
CL5093	CL5593	6 Openings - 12 x 18 x 36	121.17	145.41	177
Box Lockers					
CL5101	CL5601	1 Wide - 5 Tier - 12 x 12 x 12	57.88	69.45	47
CL5111	CL5611	1 Wide - 5 Tier - 12 x 15 x 12	59.11	70.91	51
CL5121	CL5621	1 Wide - 6 Tier - 12 x 12 x 12	56.53	67.82	54
CL5131	CL5631	1 Wide - 6 Tier - 12 x 15 x 12	57.88	69.45	59
CL5141	CL5641	1 Wide - 6 Tier - 12 x 18 x 12	61.07	73.27	64
CL5103	CL5603	3 Wide - 5 Tier - 12 x 12 x 12	48.37	58.04	141
CL5113	CL5613	3 Wide - 5 Tier - 12 x 15 x 12	49.24	59.10	153
CL5123	CL5623	3 Wide - 6 Tier - 12 x 12 x 12	47.20	56.62	162
CL5133	CL5633	3 Wide - 6 Tier - 12 x 15 x 12	48.37	58.04	171
CL5143	CL5543	3 Wide - 6 Tier - 12 x 18 x 12	51.02	61.22	192
CL515	CL615	16 Person Box Locker	948.33	1,138.01	172

CLASS D

CITADEL INDUSTRIAL LOCKERS

ALLIANCE HANDLE CATALOG PAGE 150

Unassembled **70**
 Set-Up **100**

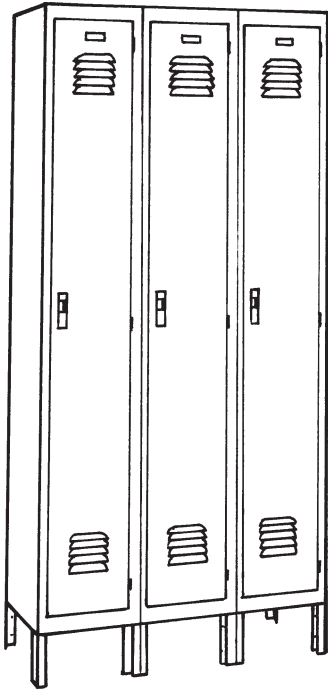

SINGLE TIER (3 WIDE)

Product # Unassembled	Product# Set-Up	Description W" x D" x H"	List Price Per Opening Unassembled	List Price Per Opening Set-Up	Shpg. Wt.
Single Tier (1 Wide)					
CL2001	CL2501	1 Opening - 12 x 12 x 60	213.77	267.22	45
CL2011	CL2511	1 Opening - 12 x 15 x 60	223.63	279.52	48
CL2021	CL2521	1 Opening - 12 x 18 x 60	237.06	296.32	51
CL2031	CL2531	1 Opening - 12 x 12 x 72	235.87	294.83	51
CL2041	CL2541	1 Opening - 12 x 15 x 72	244.55	305.71	55
CL2051	CL2551	1 Opening - 12 x 18 x 72	259.27	324.10	59
CL2061	CL2561	1 Opening - 15 x 18 x 72	283.40	354.24	66
Single Tier (3 Wide)					
CL2003	CL2503	3 Openings - 12 x 12 x 60	178.24	222.81	135
CL2013	CL2513	3 Openings - 12 x 15 x 60	186.35	232.94	144
CL2023	CL2523	3 Openings - 12 x 18 x 60	197.56	246.93	153
CL2033	CL2533	3 Openings - 12 x 12 x 72	196.54	245.68	153
CL2043	CL2643	3 Openings - 12 x 15 x 72	204.01	255.01	165
CL2053	CL2553	3 Openings - 12 x 18 x 72	216.08	270.11	177
CL2063	CL2563	3 Openings - 15 x 18 x 72	236.09	295.10	198
Double Tier (1 Wide)					
CL2071	CL2571	2 Openings - 12 x 12 x 36	135.66	169.59	52
CL2081	CL2581	2 Openings - 12 x 15 x 36	142.46	178.08	56
CL2091	CL2591	2 Openings - 12 x 18 x 36	148.31	185.38	59
Double Tier (3 Wide)					
CL2073	CL2573	6 Openings - 12 x 12 x 36	113.03	141.28	156
CL2083	CL2583	6 Openings - 12 x 15 x 36	118.58	148.25	168
CL2093	CL2593	6 Openings - 12 x 18 x 36	123.64	154.53	177

Overall height of locker frame is 60" or 72". Add 6" for legs. Add Product Number Suffix (BU) BLUE, (GY) GRAY or (TN) TAN. All prices listed are per opening.
SEE ABOVE FOR ACCESSORIES

CLASS D

CITADEL PREMIER LOCKERS

RECESSED HANDLE CATALOG PAGE 151

Unassembled **70**
 Set-Up **100**



SINGLE TIER



DOUBLE TIER

Product # Unassembled	Product# Set-Up	Description W" x D" x H"	List Price Per Opening Unassembled	List Price Per Opening Set-Up	Shpg. Wt.
Single Tier (1 Wide)					
CL3031	CL3531	1 Opening - 12 x 12 x 72	276.08	345.11	59
CL3041	CL3541	1 Opening - 12 x 15 x 72	286.29	357.82	63
CL3051	CL3551	1 Opening - 12 x 18 x 72	303.48	379.34	67
Single Tier (3 Wide)					
CL3033	CL3533	3 Openings - 12 x 12 x 72	230.03	287.53	177
CL3043	CL3543	3 Openings - 12 x 15 x 72	238.80	298.51	189
CL3053	CL3553	3 Openings - 12 x 18 x 72	252.95	316.18	201
Double Tier (1 Wide)					
CL3071	CL3571	2 Openings - 12 x 12 x 36	158.79	198.53	60
CL3081	CL3581	2 Openings - 12 x 15 x 36	166.74	208.42	64
CL3091	CL3591	2 Openings - 12 x 18 x 36	173.57	216.99	68
Double Tier (3 Wide)					
CL3073	CL3573	6 Openings - 12 x 12 x 36	132.31	165.36	180
CL3083	CL3583	6 Openings - 12 x 15 x 36	138.82	173.54	192
CL3093	CL3593	6 Openings - 12 x 18 x 36	144.76	180.94	204

Overall height of locker frame is 72". Add 6" for legs. Add Product Number Suffix (BU) BLUE, (GY) GRAY or (TN) TAN. All prices listed are per opening.

SEE PAGE 78 FOR ACCESSORIES

**CLASS
D**

CITADEL VENTILATED LOCKERS

RECESSED HANDLE

Unassembled

70



Set-Up

100



CATALOG PAGE 152

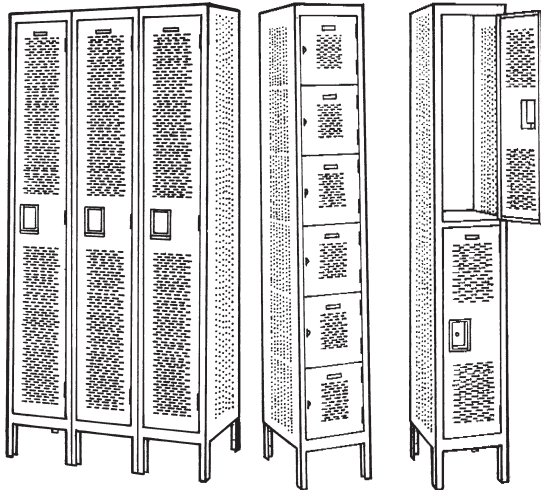

SINGLE TIER BOX DOUBLE TIER

Overall height of locker frame is 72". Add 6" for legs.
Add Product Number Suffix (GY) GRAY, (TN) TAN or (BU) BLUE.
All prices listed are per opening.

Product # Unassembled	Product # Set-Up	Description W" x D" x H"	List Price Per Opening Unassembled	List Price Per Opening Set-Up	Shpg. Wt.
Single Tier (1 Wide)					
CL4031	CL4531	1 Opening - 12 x 12 x 72	310.40	388.00	75
CL4051	CL4551	1 Opening - 12 x 18 x 72	349.24	436.55	80
CL4061	CL4561	1 Opening - 15 x 18 x 72	362.35	452.96	98
Single Tier (3 Wide)					
CL4033	CL4533	3 Openings - 12 x 12 x 72	254.88	318.61	202
CL4053	CL4553	3 Openings - 12 x 18 x 72	284.68	355.84	236
CL4063	CL4563	3 Openings - 15 x 18 x 72	293.89	367.38	262
Double Tier (1 Wide)					
CL4071	CL4571	2 Openings - 12 x 12 x 36	170.24	212.84	80
CL4081	CL4581	2 Openings - 12 x 15 x 36	180.96	226.24	85
CL4091	CL4591	2 Openings - 12 x 18 x 36	190.64	238.34	95
Double Tier (3 Wide)					
CL4073	CL4573	6 Openings - 12 x 12 x 36	139.69	174.62	210
CL4083	CL4583	6 Openings - 12 x 15 x 36	147.86	184.82	217
CL4093	CL4593	6 Openings - 12 x 18 x 36	155.37	194.25	242
Box Lockers					
CL4121	CL4621	1 Wide-6 Tier- 12 x 12 x 12	71.73	89.65	82
CL4131	CL4631	1 Wide-6 Tier- 12 x 15 x 12	74.41	92.99	87
CL4141	CL4641	1 Wide-6 Tier- 12 x 18 x 12	78.94	98.72	92
CL4123	CL4623	3 Wide-6 Tier- 12 x 12 x 12	59.62	74.55	240
CL4133	CL4633	3 Wide-6 Tier- 12 x 15 x 12	61.68	77.15	248
CL4143	CL4543	3 Wide-6 Tier- 12 x 18 x 12	65.20	81.50	260

SEE PAGE BELOW FOR ACCESSORIES

**CLASS
D**

CITADEL Premier ALLIANCE VENTILATED LOCKERS

Unassembled

70



Set-Up

100



CATALOG PAGE 153

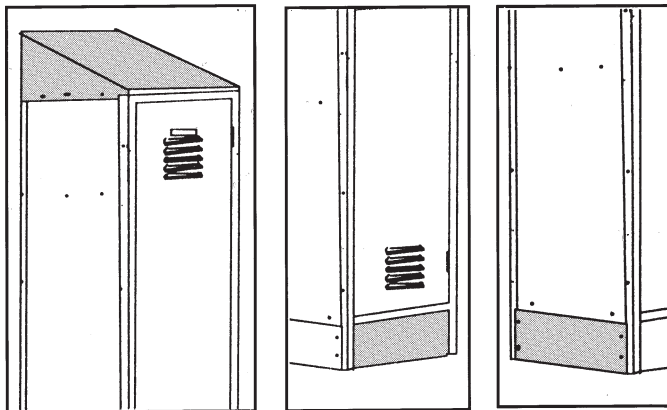

SLOPING TOP

FRONT BASE

END BASE

*Sloping top kits include: 3
Tops, 3 Backs, and 4 Sides

Product # Unassembled	Product # Setup	Product Size W" x D" x H"	List Price Ea. Unassembled	List Price Setup	Shpg. Wt. (Lbs.)
Accessories					
CL601	CL601SU	Sloping top kit* 12" - 12"	46.23	55.47	9
CL602	CL602SU	Sloping top kit* 12" - 15"	51.56	61.88	11
CL603	CL603SU	Sloping top kit* 12" - 18"	58.88	70.65	15
CL604	CL604SU	Sloping top kit* 15" - 18"	70.88	85.06	15
CL611	CL611SU	Front Base 12"	8.87	10.62	1
CL612	CL612SU	Front Base 15"	9.63	11.58	1
CL621	CL621SU	End Base 12" Single	13.22	15.86	1
CL622	CL622SU	End Base 15" Single	13.30	15.94	2
CL623	CL623SU	End Base 18" Single	14.66	17.60	2
CL624	CL624SU	End Base 24" Double	16.36	—	3
CL625	CL625SU	End Base 30" Double	16.98	—	3
CL626	CL626SU	End Base 36" Double	20.97	—	4

Add Product Number Suffix (BU) BLUE, (GY) GRAY or (TN) TAN.

Product # Unassembled	Product # Setup	Description	Unit Price Each	Unit Price Each Setup
X100	X100SU	Number Plates (1 - 250) Loose	1.09	1.23
1502	—	Combination Padlock	18.05	—
SL8	SL8SU	Cylinder Lock for Box Lockers	13.60	15.26
1630	1630SU	Built-In Combination Lock/ Single & Double Tier Lockers	39.99	45.05
1710	1710SU	Built-In Flat Key	28.64	28.50

**CLASS
D**

LODEC QUIET OPERATING LOCKERS

CATALOG PAGES 154-156

Unassembled **70** 

Set-Up **100** 

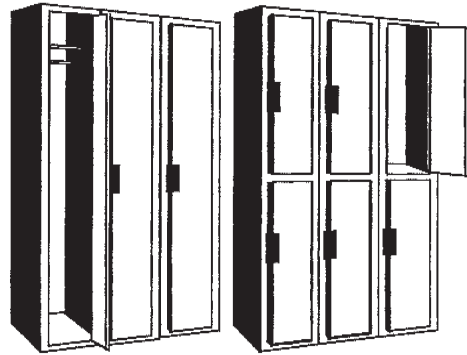

SINGLE TIER

DOUBLE TIER

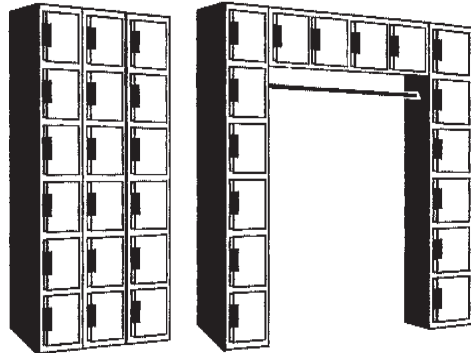

6 PERSON

16 PERSON

Single Tier Add-On

Product # Unassembled	Product # Set-Up	Overall Product Size W" x D" x H"	List Price Per Unit Unassembled	List Each Per Unit Set Up	Shpg. Wt.
Single Tier Starter					
SL8000 GY	SL8500 GY	12 x 18 x 72 Gray	230.88	277.07	59
SL8000 TN	SL8500 TN	12 x 18 x 72 Tan	230.88	277.07	59
Single Tier Add-On					
SL8001 GY	—	12 x 18 x 72 Gray	205.34	—	50
SL8001 TN	—	12 x 18 x 72 Tan	205.34	—	50
Single Tier 3 Wide					
SL8011 GY	SL8511 GY	36 x 18 x 72 Gray	641.57	769.85	159
SL8011 TN	SL8511 TN	36 x 18 x 72 Tan	641.57	769.85	159
Double Tier Starter					
SL8002 GY	SL8502 GY	12 x 18 x 72 Gray	245.16	294.16	62
SL8002 TN	SL8502 TN	12 x 18 x 72 Tan	245.16	294.16	62
Double Tier Add-On					
SL8003 GY	—	12 x 18 x 72 Gray	219.54	—	53
SL8003 TN	—	12 x 18 x 72 Tan	219.54	—	53
Double Tier 3 Wide					
SL8012 GY	SL8512 GY	36 x 18 x 72 Gray	684.23	821.06	168
SL8012 TN	SL8512 TN	36 x 18 x 72 Tan	684.23	821.06	168
Six Tier Box Starter					
SL8004 GY	SL8504 GY	12 x 18 x 72 Gray	312.22	374.65	65
SL8004 TN	SL8504 TN	12 x 18 x 72 Tan	312.22	374.65	65
Six Tier Box Add-On					
SL8005 GY	—	12 x 18 x 72 Gray	287.41	—	58
SL8005 TN	—	12 x 18 x 72 Tan	287.41	—	58
Six Tier Box, 3 Wide					
SL8014 GY	SL8514 GY	36 x 18 x 72 Gray	887.07	1,064.45	181
SL8014 TN	SL8514 TN	36 x 18 x 72 Tan	887.07	1,064.45	181
16 Person System					
SL8006 GY	—	69 x 18 x 72 Gray	912.85	—	191
SL8006 TN	—	69 x 18 x 72 Tan	912.85	—	191
Four Person Wall Mounted					
SL8007 GY	SL8517GY	45 x 18 x 12 Gray	288.48	—	61
SL8007 TN	SL8517TN	45 x 18 x 12 Tan	288.48	—	61
Cylinder Lock (w/2 keys)					
SL8	SL8SU		13.60	15.26	

LODEC Silent Lockers are priced per complete unit. When ordering LODEC Silent Lockers, order quantity of complete units required.

**CLASS
D**

LATERAL FILES

CATALOG PAGE 160

100 

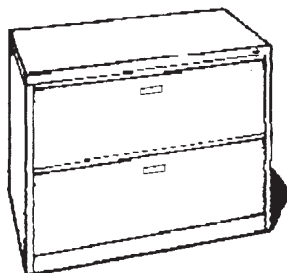

Product #	Description	Size	Color	List Each	Weight Each
E202L-BLK	2 Drawer Cabinet	30"W x 18"D x 26 ⁵ / ₈ "H	Black	407.45	90.0
E202L-PU	2 Drawer Cabinet	30"W x 18"D x 26 ⁵ / ₈ "H	Putty	407.45	90.0
E204L-BLK	4 Drawer Cabinet	30"W x 18"D x 52 ⁵ / ₈ "H	Black	811.67	180.0
E204L-PU	4 Drawer Cabinet	30"W x 18"D x 52 ⁵ / ₈ "H	Putty	811.67	180.0
E302L-BLK	2 Drawer Cabinet	36"W x 18"D x 26 ⁵ / ₈ "H	Black	499.54	100.0
E302L-PU	2 Drawer Cabinet	36"W x 18"D x 26 ⁵ / ₈ "H	Putty	499.54	100.0
E304L-BLK	4 Drawer Cabinet	36"W x 18"D x 52 ⁵ / ₈ "H	Black	873.08	200.0
E304L-PU	4 Drawer Cabinet	36"W x 18"D x 52 ⁵ / ₈ "H	Putty	873.08	200.0
E2500L	Cross Bar Kit	For 30"W drawer	-	24.74	2.0
E2501L	Cross Bar Kit	For 36"W drawer	-	49.50	4.0

**CLASS
D**

LATERAL FILES



CATALOG PAGE 161

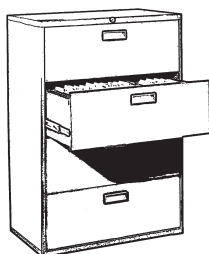

17088

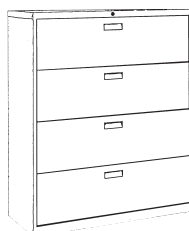

19068R

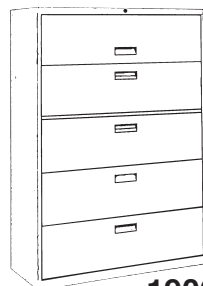

19069R

Product Number	Description	Size	List Each	Weight Each
17087	2 Drawer Cabinet	36"W x 19 ¹ / ₄ "D x 29"H	452.60	104
17088	4 Drawer Cabinet	36"W x 19 ¹ / ₄ "D x 54"H	794.81	179
19068R	4 Drawer Cabinet	42"W x 19 ¹ / ₄ "D x 54"H	883.11	199
19069R	5 Drawer Cabinet	42"W x 19 ¹ / ₄ "D x 65"H	1,092.86	253

**CLASS
D**

FULL PULL LATERAL FILES



CATALOG PAGE 161

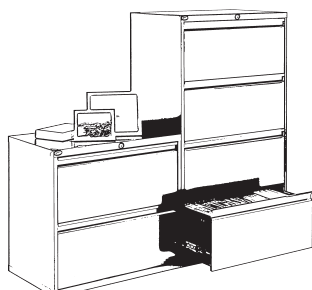

17066

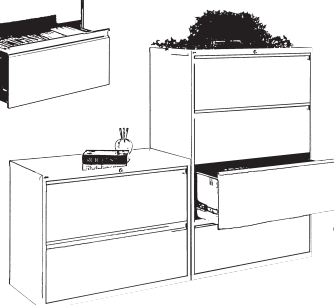

17067

Product Number	Description	Size	List Each	Weight Each
17066	2 Drawer Cabinet	30"W x 19 ¹ / ₄ "D x 29"H	430.52	99
17068	4 Drawer Cabinet	30"W x 19 ¹ / ₄ "D x 54"H	662.15	182
17069	2 Drawer Cabinet	36"W x 19 ¹ / ₄ "D x 29"H	496.75	109
17067	4 Drawer Cabinet	36"W x 19 ¹ / ₄ "D x 54"H	861.03	184

**CLASS
D**

COMBO CABINETS



CATALOG PAGE 162

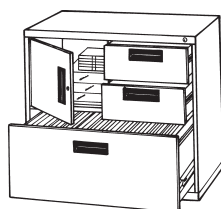

E8000L

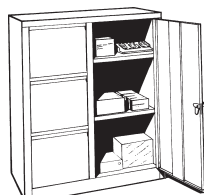

3801



3800

Product Number	Size W" x D" x H"	Color	List Each	Weight Each
1 Box Drawer - 2 File Drawers				
3800	36 x 18 x 35 ⁵ / ₈	Putty	471.39	78
3800BLK	36 x 18 x 35 ⁵ / ₈	Black	471.39	78
3 File Drawers				
3801	36 x 18 x 42	Putty	548.12	91
3801BLK	36 x 18 x 42	Black	548.12	91
4 in 1 Lateral File Center				
E8000L-BLK	30 x 18 x 26 ⁵ / ₈	Black	527.05	82
E8000L-PU	30 x 18 x 26 ⁵ / ₈	Putty	527.05	82

CLASS C FLAT FILES



CATALOG PAGE 163

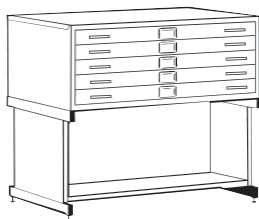

244876
& 244878



(2) 244879
& 244880

Product #	Description	Size (W x D x H)	List Ea.	Wt. Ea.
244876LG	5 Drawer Flat File	40 3/4" x 28 3/8" x 15 3/4"	\$520.81	145.0
244876PU	5 Drawer Flat File	40 3/4" x 28 3/8" x 15 3/4"	\$520.81	145.0
244877LG	Closed Base	40 3/4" x 28 3/8" x 4 3/4"	\$69.63	14.0
244877PU	Closed Base	40 3/4" x 28 3/8" x 4 3/4"	\$69.63	14.0
244878LG	Open Base	40 3/4" x 28 3/8" x 20"	\$244.06	36.0
244878PU	Open Base	40 3/4" x 28 3/8" x 20"	\$244.06	36.0
244879LG	5 Drawer Flat File	46 3/4" x 35 3/8" x 15 3/4"	\$665.86	185.0
244879PU	5 Drawer Flat File	46 3/4" x 35 3/8" x 15 3/4"	\$665.86	185.0
244880LG	Closed Base	46 3/4" x 35 3/8" x 4 3/4"	\$72.66	16.0
244880PU	Closed Base	46 3/4" x 35 3/8" x 4 3/4"	\$72.66	16.0
244881LG	Open Base	46 3/4" x 35 3/8" x 20"	\$260.41	52.0
244881PU	Open Base	46 3/4" x 35 3/8" x 20"	\$260.41	52.0
244882LG	5 Drawer Flat File	55 3/4" x 41 3/8" x 15 3/4"	\$854.79	227.0
244882PU	5 Drawer Flat File	55 3/4" x 41 3/8" x 15 3/4"	\$854.79	227.0
244883LG	Closed Base	55 3/4" x 41 3/8" x 4 3/4"	\$78.73	18.0
244883PU	Closed Base	55 3/4" x 41 3/8" x 4 3/4"	\$78.73	18.0
244884LG	Open Base	55 3/4" x 41 3/8" x 20"	\$299.77	70.0
244884PU	Open Base	55 3/4" x 41 3/8" x 20"	\$299.77	70.0

CLASS D VERTICAL FILING CABINETS



CATALOG PAGE 163

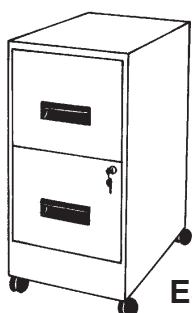

E501

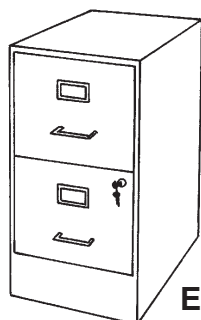

E500

Model No.	Description	List Each	Wt. Each
E500-BLK	2 Drawer Commercial Grade Vertical Filing Cabinet, 15"W x 22"D x 26-7/8"H, Black	\$208.53	39.0
E500-PU	2 Drawer Commercial Grade Vertical Filing Cabinet, 15"W x 22"D x 26-7/8"H, Putty	\$208.53	39.0
E501-BLK	2 Drawer Commercial Grade Mobile File Pedestal, 15"W x 22"D x 29"H, Black	\$253.02	42.0
E501-PU	2 Drawer Commercial Grade Mobile File Pedestal, 15"W x 22"D x 29"H, Putty	\$253.02	42.0

CLASS D PEDESTAL CABINETS



CATALOG PAGE 164

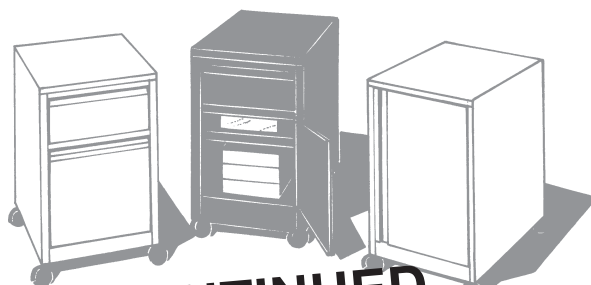

DISCONTINUED

Product #	Description	Size	Color	List Each	Wt Each
PC1B	Pedestal Cabinet, Door Only	15"W x 20"D x 24"H	Black	-	39.0
PC1P	Pedestal Cabinet, Door Only	15"W x 20"D x 24"H	Putty	-	39.0
PC2B	Pedestal Cabinet, One Drawer w/Door	15"W x 20"D x 24"H	Black	-	43.0
PC2P	Pedestal Cabinet, One Drawer w/Door	15"W x 20"D x 24"H	Putty	-	43.0
PC3B	Pedestal Cabinet, Two Drawer	15"W x 20"D x 24"H	Black	-	56.0
PC3P	Pedestal Cabinet, Two Drawer	15"W x 20"D x 24"H	Putty	-	56.0



**CLASS
D**

ROLLAWAYS



CATALOG PAGE 164

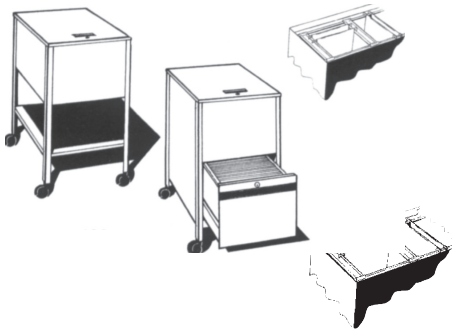

Product #	Description	Size	Color	List Each	Wt Each
E800BLK	Standard, Letter/Open	13½"W x 24¾"D x 28"H	Black	246.70	30.0
E800PU	Standard, Letter/Open	13½"W x 24¾"D x 28"H	Putty	246.70	30.0
RTO11B	Deluxe, Letter/Open	13½"W x 24¾"D x 28"H	Black	322.87	31.0
RTO11P	Deluxe, Letter/Open	13½"W x 24¾"D x 28"H	Putty	322.87	31.0
RTD11B	Deluxe, Letter w/Drawer	16½"W x 24¾"D x 28"H	Black	613.51	59.0
RTD11P	Deluxe, Letter w/Drawer	16½"W x 24¾"D x 28"H	Putty	613.51	59.0
RTO18B	Deluxe, Legal/Open	16½"W x 24¾"D x 28"H	Black	337.95	35.0
RTO18P	Deluxe, Legal/Open	16½"W x 24¾"D x 28"H	Putty	337.95	35.0
RTD18B	Deluxe, Legal w/Drawer	19½"W x 25¾"D x 28"H	Black	631.10	64.0
RTD18P	Deluxe, Legal w/Drawer	19½"W x 25¾"D x 28"H	Putty	631.10	64.0
RTCK11	Deluxe, Letter Conversion Kit			18.71	2.0
RTCK18	Deluxe, Legal Conversion Kit			19.27	2.0

**CLASS
D**

MACHINE STAND



CATALOG PAGE 164

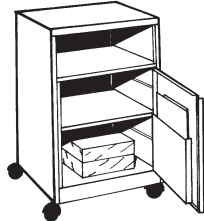

MS2617P

Product #	Description	Size W x D x H	Color	List Each	Wt Each
MS2617P	Machine Stand	17¼" x 17¼" x 26½"	Putty	285.62	35.0

**CLASS
D**

MULTI-MEDIA STORAGE CABINETS



CATALOG PAGE 165

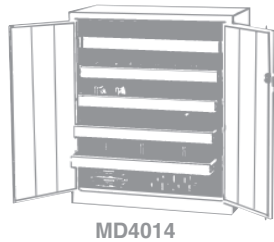

MD4014

DISCONTINUED



MD4015

Product #	Description	List Each	Wt Each
MD4014	42" Media Cabinet	-	82.0
MD4015	72" Media Cabinet	-	130.0
MD4016	Roll-out Drawer	-	11.0
MD4010	Drawer Divider Video Kit	-	7.0
MD4011	Drawer Divider DLT Kit	-	7.0
MD4012	Drawer Divider Audio Kit	-	9.0
MD4013	Drawer Divider DAT Kit	-	11.0
MD4017	5"H Caster Kit (4 per kit)	-	10.0

**CLASS
C**

DRAWER CASES



CATALOG PAGE 165

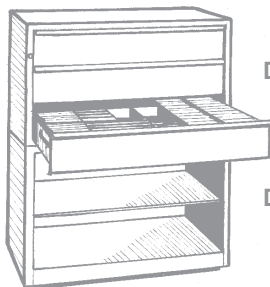

DC3403

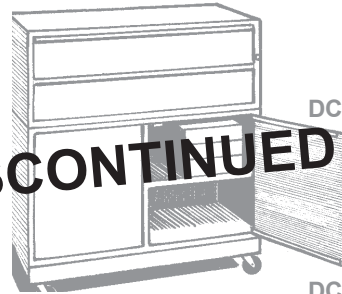

DC3402

DISCONTINUED

DC3400

DC3401

DC3404

Product Number	Size	List Price Each	Approx. Shpg. Wt.
DC3400	Open Shelf Case	-	77
DC3401	Door Case	-	56
DC3402	2 Drawer Case	-	79
DC3403	3 Drawer Case	-	109
DC3404	Caster Base	-	20
DCK3405	Divider Kit	-	4



DCK3405

CLASS D

AMBASSADOR OFFICE SHELVING



CATALOG PAGES 166 & 167

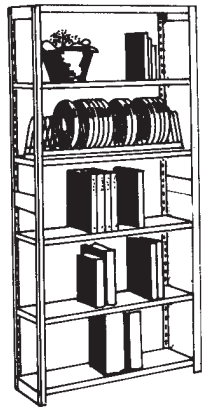

STARTER UNIT

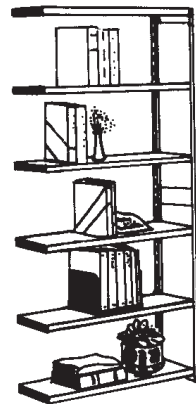

ADD-ON UNIT OPEN SHELF

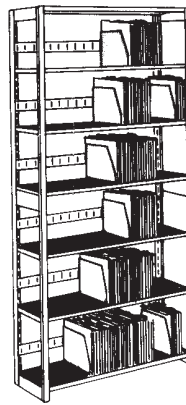

FILING

Starter Unit

Product Number	No. Of Shelves	Size W" x D" x H"	List Price	Shg. Wt. (Lbs.)
AS12365S	5	36 x 12 x 76	197.01	66
AS12366S	6	36 x 12 x 76	219.49	76
AS15365S	5	36 x 15 x 76	216.15	77
AS15366S	6	36 x 15 x 76	241.46	87
AS18365S	5	36 x 18 x 76	231.13	86
AS18366S	6	36 x 18 x 76	259.08	99

Add-On Unit

Product Number	No. Of Shelves	Size W" x D" x H"	List Price	Shpg. Wt. (Lbs.)
AS12365A	5	36 x 12 x 76	164.92	58
AS12366A	6	36 x 12 x 76	187.36	66
AS15365A	5	36 x 15 x 76	182.85	64
AS15366A	6	36 x 15 x 76	208.10	73
AS18365A	5	36 x 18 x 76	196.58	71
AS18366A	6	36 x 18 x 76	224.48	81

Open Shelf Filing System

Product Number	No. Of Shelves	Size W" x D" x H"	List Price	Shpg. Wt. (Lbs.)
AF7612S	7	36 x 12 x 76	339.78	98
AF7612A	7	36 x 12 x 76	314.15	95

Additional Dividers

Product Number	List Price	Shpg. Wt. (Lbs.)
AF76-DIV	3.41	1.0

CLASS D

STEEL DESKS



CATALOG PAGE 168 & 169

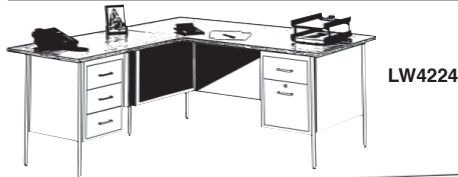

LW4224



DP7236

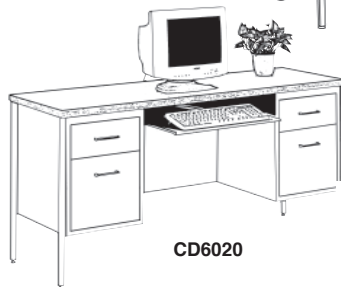

CD6020

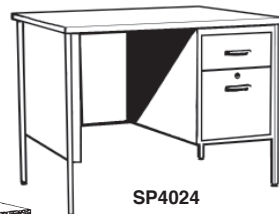

SP4024

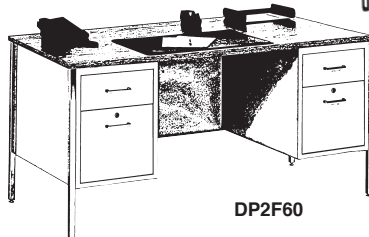

DP2F60

Product #	Description	Size W x D	Color	List Ea.	Wt. Ea.
SP4024-BW	Single Pedestal Desk	40" x 24"	Black/Walnut	469.41	86.0
SP4024-GY	Single Pedestal Desk	40" x 24"	Gray/Gray	469.41	86.0
SP4024-PU	Single Pedestal Desk	40" x 24"	Putty/Teak	469.41	86.0
DP6030-BW	Double Pedestal Desk	60" x 30"	Black/Walnut	671.03	185.0
DP6030-GY	Double Pedestal Desk	60" x 30"	Gray/Gray	671.03	185.0
DP6030-PU	Double Pedestal Desk	60" x 30"	Putty/Teak	671.03	185.0
DP2F60-BW	Double Pedestal Desk	60" x 30"	Black/Walnut	721.31	185.0
DP2F60-GY	Double Pedestal Desk	60" x 30"	Gray/Gray	721.31	185.0
DP2F60-PU	Double Pedestal Desk	60" x 30"	Putty/Teak	721.31	185.0
DP7236-BW	Double Pedestal Desk	72" x 36"	Black/Walnut	799.97	210.0
DP7236-GY	Double Pedestal Desk	72" x 36"	Gray/Gray	799.97	210.0
DP7236-PU	Double Pedestal Desk	72" x 36"	Putty/Teak	799.97	210.0
CD6020-BW	Credenza	60" x 20"	Black/Walnut	736.00	170.0
CD6020-GY	Credenza	60" x 20"	Gray/Gray	736.00	170.0
CD6020-PU	Credenza	60" x 20"	Putty/Teak	736.00	170.0
PDRW-BW	Center Drawer		Black	77.88	8.5
PDRW-GY	Center Drawer		Gray	77.88	8.5
PDRW-PU	Center Drawer		Putty	77.88	8.5
KD200-BW	Sliding Keyboard Drawer		Black	71.52	8.0
KD200-GY	Sliding Keyboard Drawer		Gray	71.52	8.0
KD200-PU	Sliding Keyboard Drawer		Putty	71.52	8.0
LW4224-BW	"L" Wing		Black/ Walnut	1,212.99	273.0
LW4224-GY	"L" Wing		Gray/Gray	1,212.99	273.0
LW4224-PU	"L" Wing		Putty/Teak	1,212.99	273.0
RW4224-BW	"R" Wing		Black/ Walnut	1,212.99	273.0
RW4224-GY	"R" Wing		Gray/Gray	1,212.99	273.0
RW4224-PU	"R" Wing		Putty/Teak	1,212.99	273.0

**CLASS
D**

A/V CARTS



CATALOG PAGE 170

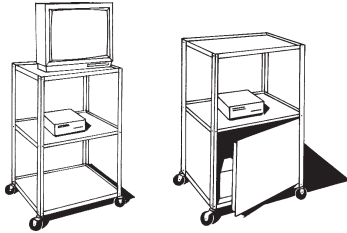

Product #	Description	Size	Color	List Each	Wt Each
AV2418	A/V Cart, Open	24"W x 18"D	Black	266.87	38.0
AV24181	A/V Cart, Closed w/Door	24"W x 18"D	Black	428.74	54.0

**CLASS
C**

STACK-N-FILE



CATALOG PAGE 170

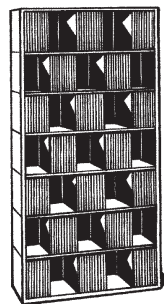

Product Number	Size	List Price Each	Approx. Shpg. Wt.
Top & Base			
SF2200P	Letter	66.92 set	20
SF2201P	Legal	74.72 set	23
Shelves (2)			
SF2202P	Letter	159.58 pair	45
SF2203P	Legal	174.99 pair	51

**CLASS
D**

ALL WELDED STEEL BOOKCASES



CATALOG PAGE 171



EBC 30

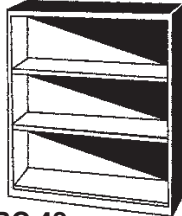

EBC 42

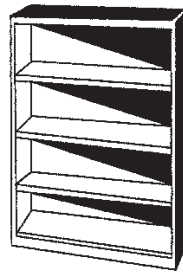

EBC 53

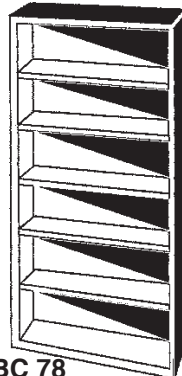

EBC 78

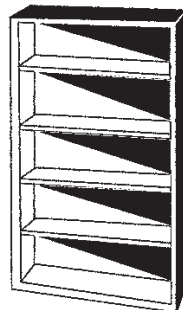

EBC 66

Product Number	Description W" x D" x H"	Color	List Each	Approx. Shp. Wt. Ea.
EBC30GY	36 x 13 x 29	Gray	166.72	46
EBC30TN	36 x 13 x 29	Tan	166.72	46
EBC30BLK	36 x 13 x 29	Black	166.72	46
EBC30PU	36 x 13 x 29	Putty	166.72	46
EBC42GY	36 x 13 x 40	Gray	198.98	58
EBC42TN	36 x 13 x 40	Tan	198.98	58
EBC42BLK	36 x 13 x 40	Black	198.98	58
EBC42PU	36 x 13 x 40	Putty	198.98	58
EBC53GY	36 x 13 x 52½	Gray	279.73	76
EBC53TN	36 x 13 x 52½	Tan	279.73	76
EBC53BLK	36 x 13 x 52½	Black	279.73	76
EBC53PU	36 x 13 x 52½	Putty	279.73	76
EBC66GY	36 x 13 x 66	Gray	331.30	89
EBC66TN	36 x 13 x 66	Tan	331.30	89
EBC66BLK	36 x 13 x 66	Black	331.30	89
EBC66PU	36 x 13 x 66	Putty	331.30	89
EBC78GY	36 x 13 x 78	Gray	381.10	102
EBC78TN	36 x 13 x 78	Tan	381.10	102
EBC78BLK	36 x 13 x 78	Black	381.10	102
EBC78PU	36 x 13 x 78	Putty	381.10	102

Additional Shelves Only

Product Number	Description	Color	List Each	Approx. Shp. Wt. Ea.
EBCSGY	Shelf 35 ⁵ / ₈ x 12	Gray	21.93	5.5
EBCSTN	Shelf 35 ⁵ / ₈ x 12	Tan	21.93	5.5
EBCSBLK	Shelf 35 ⁵ / ₈ x 12	Black	21.93	5.5
EBCSPU	Shelf 35 ⁵ / ₈ x 12	Putty	21.93	5.5

CATALOG NUMBER INDEX

<i>Model No</i>	<i>Price List Pg</i>	<i>Model No</i>	<i>Price List Pg</i>	<i>Model No</i>	<i>Price List Pg</i>
2AF-1000.....	14, 32	3015-B to 4815-F.....	14	CL2001 to CL2643	77
2AT-36 to 2AT-42.....	32	3610 to 4815-UCF.....	13-14	CL3031 to CL3593	77
2DES-9 to 2DES-12	32	3800 to 3801.....	80	CL4031 to CL4641	78
2MB-1000.....	32	4000 to 4003.....	67-68	CL5001 to CL5643	76
2PC-1100.....	32	4210 to 4236-S.....	13	CS15 to CS48.....	28
2SEP-15.....	32	4810 to 4836-S.....	13	CSC6500 to CSC6501	63
2WT-9 to 2WT-12	32	5301 to 5312-30T	48	CSC6625	64
5-GB.....	14	5301TA to 5308TAT	54	CSC6718.....	65
12-SB to 36-SB.....	13	5313 to 5324-30T	49	CSC6726 to CSC6775	64
12UCB to 48UCB	13	5409 to 5506.....	53	CSC6780.....	65
24-RB to 48-RB.....	14	5601 to 5710.....	53-54	CSC6790 to CSC6820G.....	64
30-LH to 48-LH.....	14	5625 to 5848PD.....	30	CSC6850 to CSC6900	65
36-BB to 48-BB.....	13	6310MT to 6334S.....	53	CSR6800.....	64
4625 to 4848PD.....	30	6600 to 6605.....	66	CT2043-3 to CT2436-5.....	43
49-P to 121-P.....	13	6625 to 6848WD.....	31	CV1250 to CV1272.....	70
66STN to 67STN	66	7000 to 7009.....	66-67	CV1273 to CV1275.....	71
124 to 189-D.....	13-14	7625 to 7848WD.....	31	CVP30 to CVP48.....	71
215-12-3 to 218-24-4	5	7800 to 7813.....	69	DC3400 to DCK3405.....	11, 82
225-12-3 to 228-24-4	6	8624RE to 8848RE.....	29	DDK2 to DDK4	73
242 to 246-2436	11	9524BM to 9848BMPD.....	29, 30	DML6030 to DMT7236	52
244 to 249-D.....	13-14	9524BMS to 9848BMWWD	31	DP2F60	83
250-24-I to 253-24-S	11	17066 to 19069R	80	DP6030 to DP7236.....	83
260 to 263.....	11	59242 to 59243.....	60	E202L to E304L.....	79
270-01 to 290-181	10, 14	41025 to 41048PD.....	30	E500 to E501.....	81
303-F to 483-F.....	14	51025 to 51048PD.....	30	E-702 to E-704	53, 56
304 to 369.....	13	61025 to 61048WD.....	31	E2500 to E2501.....	79
424 to 489.....	13-14	71025 to 71048WD.....	31	E-7200 to E-7215	56
600-60-L to 604-60-W	55	81024RE to 81048RE.....	29	E-7216 to E-7221	56
603ST2584	62	244876 to 244884.....	81	E8000L	80
605 to 609.....	55	ABL30 to ABL36	53	EADP-6.....	53, 56
620.....	61	AC300A to ACT670A.....	72	EBC30 to EBC78.....	84
630.....	60	AF76-DIV	83	EBCS.....	84
640 to 660.....	61	AF7612A to AF7612S	83	EHD4236 to EHD7860	75
800-1235 to 800-2448	7	AS1236-5A to AS1836-6S	83	ERB60 to ERB96.....	33
801-1235 to 801-2448	7	AV2418 to AV24181.....	84	ERD6024 to ERD9648	33
802-123 to 802-244	13	B49.....	20	ERF2472 to ERF48120	33
900-1235 to 900-2448	4	B420 to B449.....	58	ERTB24 to ERTB48	33
901-1235 to 901-2448	4	BB3060 to BB3696	54	ERP6024 to ERP9648120S	34
902-123 to 902-244	13	BC4801G to BC5725	74	ERS6024 to ERS9648120S	35
1000S to 1023PWT	50	BC6200G to BC6203G	73	ERU6024 to ERU9648120S.....	34
1025D to 1048D	29	BC6204G to BC6205G.....	74	ERW6024 to ERW9648120S	35
1100-S to 1123-PWT	50	BD2318.....	54	ERX6018 to ERX963696S	39
1124PS to 1148PS	29	BML6030 to BMT7236.....	52	ES1401P to ES1409.....	57
1200-P to 1210-P	15	BW2003 to BWTB48	36	EW-1.....	53, 56, 57
1210 to 1218-D.....	13-14	CB2000T to CB2001T	59	EWA60307 to EWP72366	57
1250 to 1263.....	15	CB212 to CB812.....	19	EWT9554 to EWT9574.....	45
1300-S to 1423-PWT	51	CB721836.....	62	FAST5.....	17
1502.....	78	CBD1836.....	62	FSC500 to FSC502	19
1510 to 1518-D.....	13-14	CBD2002T to CBL2011T	59	GB504281 to GB504526	37-38
1630 to 1710SU.....	78	CBD3618BLK to CBD4824TN.....	69	GFRA3618 to GFRS4824	25
1810 to 1818-D.....	13-14	CBM1.....	19	GLT3060 to GLT3696	54
2301-12 to 2308-24	8	CBM2008T to CBT2013T	59	GOAS3060 to GOAS3672.....	54
2309-12 to 2317-18	9	CC40 to CC96	19	GP10	17
2318-12 to 2324-18	10	CD6020	83	HCU-361884 to HC-963696	28
2410 to 2418-D.....	13-14	CL3.....	46	HT6700 to HT6707	41
2912-5 to 2924-8.....	15	CL10.....	54, 55	IML6030 to IMT7236	52
2912-5CL to 2924-8CL.....	15	CL515.....	76	ISP.....	14
3000 to 3009.....	67-68	CL601 to CL612SU	78	KD200.....	83
3010.....	13	CL615.....	76	L5328 to L5339-30T	48
3011 to 3012	67	CL621 to CL626	78	L5347 to L5358-30T	49

INDEX CONTINUED ON PAGE 86

CATALOG NUMBER INDEX

<i>Model No</i>	<i>Price List Pg</i>	<i>Model No</i>	<i>Price List Pg</i>	<i>Model No</i>	<i>Price List Pg</i>
LP1819 to LP3619.....	21	RB212 to RB232.....	40	SS520 to SS528.....	63
LPA19 to LPA50	21	RF200 to RF211	40	ST-48 to ST-72	53
LW4224	83	RFB12 to RFB48	27	ST3060 to ST3696	54
LWB2448 to LWB3072	47	RL2400 to RL2452	22	ST8000 to ST9003	42
M5331 to M5342-30T	48	RLB36 to RLB96HD	27	SW01010T to SW02010T.....	62
M5350 to M5361-30T	49	RLPB1236 to RLPB2448	25	SWH24F	71
MB300 to MB400	46	RLPB1236 to RLPB4896.....	28	T-22028 to T-32436	43
MBR1000 to MBR2000.....	14	RLPB1542 to RLPB3069.....	26	TA11182430 to TA11362430.....	76
MD4010 to MD4017	82	RLPB2448 to RLPB4896.....	22	TA2R462442.....	76
MDC7 to MDC13	73	RLPB2460 to RLPB4896 ..29, 33, 36		TA3R242460 to TA3R462460.....	76
MDP4 to MDP5.....	60	RLPT5 to RLPT10	27	TA4R302466 to TA4R462472.....	76
MDPL411 to MDPS419	59	RLRS2309 to RLRS2416	26	TACR362460 to TACR462472.....	76
MR-2 to MR-1848	21	RLSU5 to RLSU10	27	TAWR362472 to TAWR462472	76
MS2617P.....	82	RLU60 to RLU120	27	TB1230 to TB1233	58
MSB3000 to MSB4000	14	RMA34824 to RMA39648.....	23	TB1273 to TB1276	57
MT2501 to MT2506	45	RMA44824 to RMA49648.....	24	TB1280 to TB1281	58
OT2043-3 to OT2436-5	42	RMB48 to RMB96.....	27	TBA60307 to TBP72366.....	57
PB300 to PB320	18	RMC24 to RMF48.....	28	TB-TCS60 to TB-UTS60.....	58
PB512 to PB818.....	18	RMD24 to RMD48	28	TC-22028 to TC-32436.....	43
PB8500 to PB8505	19	RMP32448 to RMP34896.....	23	TCD-22028 to TCD-32436	43
PBD5 to PBD8.....	18	RMP42448 to RMP44896.....	24	TD-22028 to TD-32436.....	43
PBD8506 to PBD8509.....	19	RMS48243 to RMS96483.....	23	TP-8850 to TP-91080	32
PBE3509 to PBE3511	53	RMS48244 to RMS96484.....	24	TR-8851 to TR-91082.....	32
PBR8510 to PBR8528.....	20	RMU34824 to RMU39648	23	TRB6012 to TRB6042	26
PBS8510 to PBS8514	20	RMU44824 to RMU49648	24	TRWA6018 to TRWS9618	39
PC1 to PC3.....	81	RR31318 to RR42348	26	TSH	76
PC40 to PC60.....	72	RS-3 to RS-4	27	TT1824-2 to TT1824-C.....	43
PCD2436 to PCD3672	45	RS12 to RS24.....	27	TW9500 to TW9519	44
PCM940 to PCM960.....	72	RS1500 to RS1517.....	25	TW9550 to TW9553	45
PCT7810 to PCT7811	60	RSA6018 to RSA9636	39	UB400 to UB800	47
PDK3 to PDK12.....	60	RSC12 to RSC20	26	UBM4830 to UBM7230.....	47
PDRW.....	83	RSS6018 to RSS9636	39	UC5112 to UC5559	12
PEA60307 - PEP60304	57	RT362454-3 to RT602466-4	26	UA5172 to UA5583.....	12
PL3503 to PL3504.....	53	RTCK11 to RTCK18	82	UCP7300 to UCP9700	13
PL6 to PL7.....	60	RTD11 to RTD18	82	UCS5020 to UCS5470	13
PMB782C to PMB783D.....	62	RTO11 to RTO18.....	82	UR1836 to UR3672	21
PMB7808 to PMB7816	46	RW4224.....	83	UR-60	21
PMD2436 to PMD3672.....	45	RWD2448 to RWD4896	22, 28	UT2043-3 to UT2436-5.....	43
PML6030 to PMT7236.....	52	RWD2460 to RWD4896 ..29, 33, 36		VBR-8850 to VBR-9880	32
PNE2436 to PNE3672.....	45	S-12 to S-24	15	VC1500G to VC1505G.....	75
PR3505 to PR3506.....	53	S3911G to S3912G	47	VC362448 to VC482472	75
PR6000 to PR6200.....	19	S700MTC to S702MTC	47	VCEX136G to VCEX348G	75
PR6550 to PR6556.....	17	SA-21005 to SA-31210.....	17	W5325 to W5336-30T	48
PS3507 to PS3508.....	54	SAC-1 to SAC-5SB.....	17	W5343 to W5355-30T	49
PS3513 to PS3514.....	53	SAP12-105 to SAP14-1210.....	17	WC-1	20
PSB6500 to PSB6515	17	SC12F to SC22F	72	WC183642 to WC183672.....	75
PSC2436 to PSC3672.....	45	SC1800 to SC1803T	42	WC183678 to WC184878.....	75
PSD3512	54	SC2016 to SC3224.....	41	WC243672.....	75
PSD6833G	61	SC300F to SC600F	71	WC243678 to WC244878.....	75
PSD7812 to PSD7813.....	61	SC5000 to SC6003.....	42	WCS123131	62
PST2436T to PST3672T	45	SCM730F to SCM760F	72	WD1218.....	41, 47
PT2442 to PT3060	41	SCMB20048	42	WDMB20047	62
PTA3500 to PTA3502	54	SCS24	71	WIT730 to WIT732	44
PW5301 to PW5312-30T.....	48	SCS350F to SCS650F	71, 72	WMT3618 to WMT6030	61
PW5301TA to PW5306TA.....	54	SD2014.....	54	WOS1600 to WOS1603	44
PW5313 to PW5324-30T.....	49	SD2014AMK.....	44, 45	WS-704.....	43
RA218 to RA233.....	40	SF2200P to SF2203P.....	84	WS600 to WS677	16
RAP32448 to RAP34896	23	SL8 to SL8SU	78, 79	WSC3018 to WSC3624.....	42
RAP42448 to RAP44896	24	SL8000 to SL8517.....	79	WT-1824-18 to WT-2448-30	61
RAS48243 to RAS96483.....	23	SP4024.....	83	X100 to X100SU.....	78
RAS48244 to RAS96484.....	24	SS400 to SS412.....	63	New items are in bold	



EDSAL MANUFACTURING COMPANY, INC.
4400 South Packers Ave., Chicago, IL 60609
773.254.0600 Fax 773.254.1303 www.edsal.com



DISTRIBUTED BY